

## Operating manual

Multiparameter bench-top meters

**HD2259.2 – HD22569.2**



Companies / Brands of GHM

Members of GHM GROUP:

**GREISINGER**

**HONSBERG**

**Martens**

**IMTRON**

**Delta OHM**

**VAL.CO**

[www.deltaohm.com](http://www.deltaohm.com)

Keep for future reference.

## TABLE OF CONTENTS

<b>INTRODUCTION</b> .....	<b>7</b>
<b>DISPLAY DESCRIPTION</b> .....	<b>8</b>
<b>KEYBOARD DESCRIPTION</b> .....	<b>15</b>
<b>MENU DESCRIPTION</b> .....	<b>18</b>
<b>USER MANAGEMENT</b> .....	<b>22</b>
Parameter Setup.....	22
Access modes .....	22
Functions reserved to the administrator .....	22
<b>pH MEASUREMENT</b> .....	<b>24</b>
Automatic or manual temperature compensation for pH measurement.....	25
pH electrode calibration .....	26
Calibration procedure.....	26
Temperature characteristics of Delta OHM standard solutions.....	28
<b>CONDUCTIVITY MEASUREMENT</b> .....	<b>29</b>
Automatic or manual temperature compensation for conductivity measurement .....	31
Resistivity, TDS and salinity measurements.....	32
Calibration of conductivity .....	32
Automatic calibration of conductivity using memorized standard solutions .....	32
Manual calibration of conductivity using not-memorized standard solutions.....	34
Table of standard solutions at 147 $\mu$ S/cm, 1413 $\mu$ S/cm, 12880 $\mu$ S/cm and 111800 $\mu$ S/cm .....	36
<b>MEASUREMENT OF THE DISSOLVED OXYGEN</b> .....	<b>37</b>
How to measure .....	37
Calibration of the dissolved Oxygen probe.....	38
Electrolyte solution and/or membrane replacement .....	39
Check the probe's status .....	41
Control the zero of the probe .....	41
Dissolved Oxygen probe storage .....	41
Polarographic probe and galvanic probe: differences.....	42
Firmware update for DO9709SM and DO9709SG probes .....	42
<b>TEMPERATURE MEASUREMENT</b> .....	<b>43</b>
How to measure .....	43
Instructions to connect the TP47 connector for Pt100 probes or Pt1000.....	44
Direct connection of the 4 wire Pt100 sensor to a DIN45326 connector.....	45
<b>WARNINGS AND OPERATING INSTRUCTIONS ON THE TEMPERATURE SENSORS</b> .....	<b>46</b>
<b>INSTRUMENT STORAGE</b> .....	<b>46</b>
<b>pH, CONDUCTIVITY AND DISSOLVED OXYGEN MEASUREMENTS - MOST FREQUENT PROBLEMS, POSSIBLE CAUSES AND HANDLING</b> .....	<b>47</b>
Instrument functioning .....	47
pH measurement .....	47
Conductivity measurement .....	48
Measurement of the dissolved Oxygen.....	48
<b>INSTRUMENT SIGNALS AND FAULTS</b> .....	<b>49</b>
<b>SERIAL INTERFACE AND USB</b> .....	<b>50</b>
<b>STORING AND TRANSFERRING DATA TO A PC</b> .....	<b>53</b>
The Record Function .....	53
Clearing the Memory.....	54
The PRINT function .....	54
<b>BACKUP BATTERY REPLACEMENT</b> .....	<b>56</b>

<b>FUNCTIONING NOTES AND OPERATING SECURITY .....</b>	<b>57</b>
<b>HD22.2 LABORATORY ELECTRODE HOLDER WITH MAGNETIC STIRRER.....</b>	<b>58</b>
<b>HD22.3 LABORATORY ELECTRODE HOLDER .....</b>	<b>58</b>
<b>COMMON TECHNICAL CHARACTERISTICS OF THE HD22... SERIES.....</b>	<b>60</b>
<b>HD2259.2 TECHNICAL CHARACTERISTICS pH - mV - MG/L O<sub>2</sub> - %O<sub>2</sub> - MBAR - °C - °F MEASUREMENT.....</b>	<b>61</b>
<b>HD22569.2 TECHNICAL CHARACTERISTICS pH - mV - X - Ω - TDS - NaCl - MG/L O<sub>2</sub> - %O<sub>2</sub> - MBAR - °C - °F MEASUREMENT.....</b>	<b>63</b>
TECHNICAL DATA OF PROBES IN LINE WITH THE INSTRUMENTS HD22... SERIES.....	67
HD2259.2 and HD22569.2 pH Electrodes ① ② .....	67
HD2259.2 and HD22569.2 Redox Electrodes ① ① .....	69
2 and 4 electrodes conductivity probes for HD22569.2.....	70
Dissolved Oxygen probes for HD2259.2 and HD22569.2 ⑥.....	71
Temperature probes .....	73
Temperature probes Pt100 using SICRAM module ⑤.....	73
4 wire Pt100 and 2 wire Pt1000 probes with TP47module ⑤ .....	74
<b>ORDER CODES THE HD22... SERIES INSTRUMENTS.....</b>	<b>75</b>
<b>COMMON ACCESSORIES FOR THE HD22... SERIES INSTRUMENTS.....</b>	<b>75</b>
<b>ACCESSORIES FOR THE HD2259.2 AND HD22569.2 INSTRUMENTS WITH INPUT FOR pH MEASUREMENT.....</b>	<b>76</b>
pH electrodes without SICRAM module (Inputs ① and ②) .....	76
pH electrodes with SICRAM module (Input ③ ) .....	76
SICRAM module with BNC input for pH electrodes (Input ③).....	76
<b>ACCESSORIES FOR THE HD22569.2 INSTRUMENT WITH CONDUCTIVITY INPUT .....</b>	<b>78</b>
<b>ACCESSORIES FOR THE HD2259.2 AND HD22569.2 INSTRUMENTS WITH INPUT FOR DISSOLVED OXYGEN MEASUREMENT.....</b>	<b>79</b>
<b>ACCESSORIES FOR THE HD22... SERIES INSTRUMENTS WITH INPUT FOR TEMPERATURE MEASUREMENT .....</b>	<b>81</b>

**HD2259.2 pH – Dissolved Oxygen – Temperature**  
**HD22569.2 pH – Conductivity – Dissolved Oxygen – Temperature**

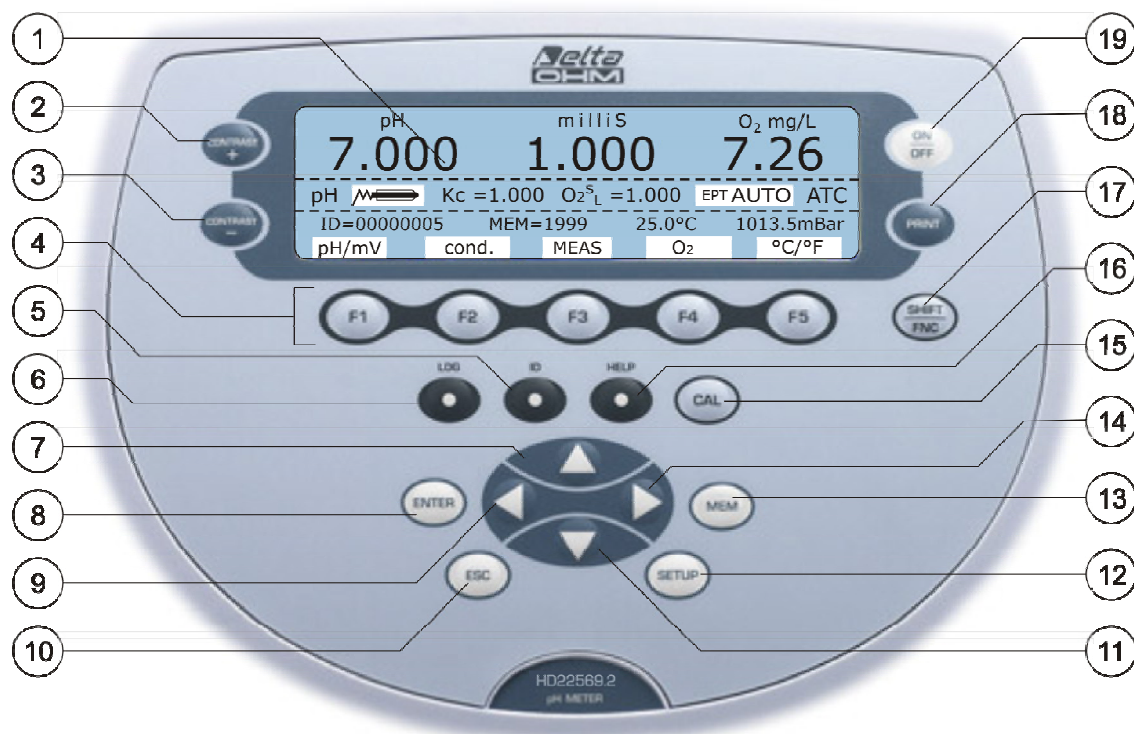

1. LCD Display
2. **CONTRAST+** key, allows to increase the display contrast.
3. **CONTRAST-** key, allows to decrease the display contrast.
4. Function keys **F1**, ..., **F5**.
5. **ID** key, allows to set the sample identifier number.
6. **LOG** key: starts and ends the saving of the data in the internal memory.
7. **▲** key: in the menu, increases the current value.
8. **ENTER** key: in the menu confirms the current selection, during measurement returns the date and time.
9. **◀** key: in the menu, moves the cursor leftwards.
10. **ESC** key: in the menu, cancels the operation in progress without making changes.
11. **▼** key: in the menu, decreases the current value.
12. **SETUP** key: allows access to the menu.
13. **MEM** key: stores the currently displayed screen.
14. **▶** key: in the menu, moves the cursor rightwards.
15. **CAL** key starts the pH electrode, conductivity probe or dissolved Oxygen probe calibration procedure.
16. **HELP** key: shows a description of the instrument main functions on the display.
17. **SHIFT/FNC** key: enables the secondary functions linked to the F1, ..., F5 keys.
18. **PRINT** key: prints the data on the current screen. It uses the serial communication port RS232C or the USB port.
19. **ON-OFF/STANDBY** key: turns the instrument on. A subsequent press of the ON-OFF key sets the instrument in standby mode.

## HD2259.2 connectors: pH – Dissolved Oxygen – Temperature

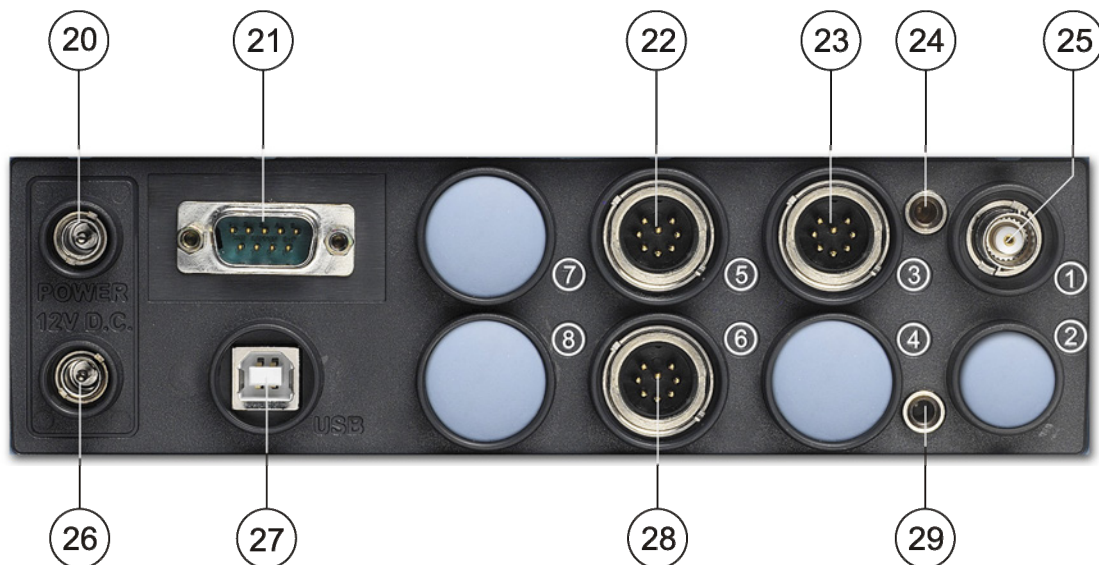

20. Power supply input 12Vdc for the  $\varnothing$  5.5mm - 2.1mm connector. Positive at centre.
21. RS232C serial port, sub D 9-pole male connector.
22. 8-pole DIN45326 connector, input for Pt100 temperature probes with SICRAM module, 4-wire direct Pt100 probes, 2-wire direct Pt1000 probes ⑤.
23. 8-pole DIN45326 connector, for the combined pH/mV/temperature electrode with SICRAM module ③.
24. Socket for  $\varnothing$  4mm standard plug for the reference electrode pH/ISE.
25. BNC connector for the pH/mV electrode ①.
26. Auxiliary power supply output 12Vdc/200mA max. for the stirrer -  $\varnothing$  5.5mm - 2.1mm connector.
27. USB 2.0 connector - type B.
28. 8-pole DIN45326 connector, input for combined dissolved Oxygen/temperature probes ⑥.
29. Not used.

## HD22569.2 connectors: pH – Conductivity – Dissolved Oxygen – Temperature

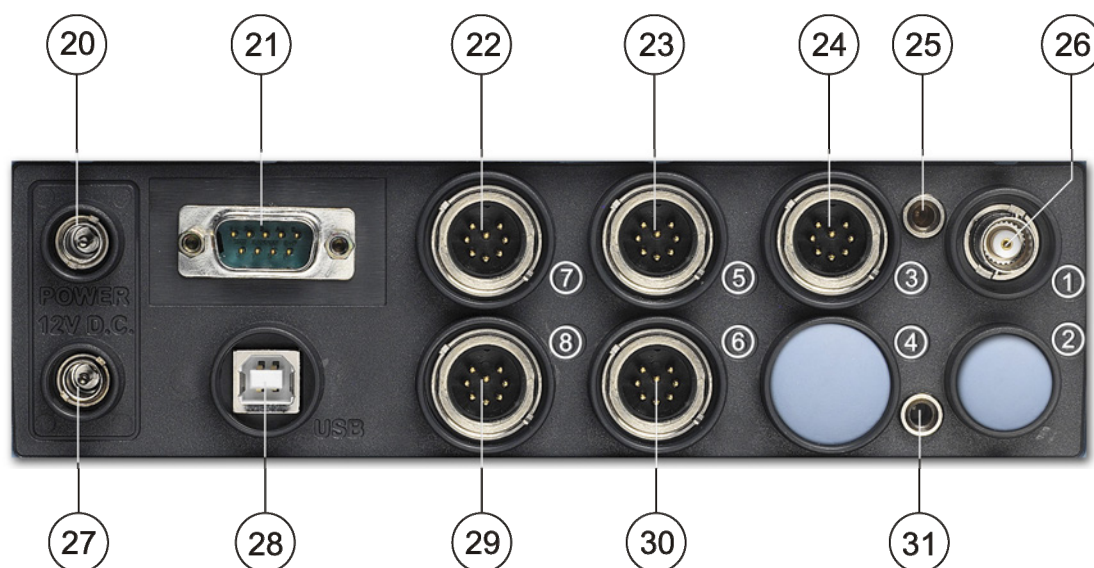

20. Power supply input 12Vdc for the  $\varnothing$  5.5mm - 2.1mm connector. Positive at centre.
21. RS232C serial port, sub D 9-pole male connector.
22. 8-pole DIN45326 connector, input for combined 4-ring or 2-ring conductivity/temperature probes **complete** with SICRAM module ⑦.
23. 8-pole DIN45326 connector, input for Pt100 temperature probes with SICRAM module, 4 wire direct Pt100 probes, 2 wire direct Pt1000 probes ⑤.
24. 8-pole DIN45326 connector, for the combined pH/mV/temperature electrode with SICRAM module ③.
25. Socket for  $\varnothing$  4mm standard plug for the reference electrode pH/ISE.
26. BNC connector for the pH/mV electrode ①.
27. Auxiliary power supply output 12Vdc/200mA for the stirrer -  $\varnothing$  5.5mm - 2.1mm connector.
28. USB 2.0 connector - type B.
29. 8-pole DIN45326 connector, input for combined 4-ring or 2-ring conductivity/temperature probes **without** SICRAM module ⑧.
30. 8-pole DIN45326 connector, input for combined dissolved Oxygen/temperature probes ⑥.
31. Not used.

## INTRODUCTION

The **HD2259.2** and **HD2569.2** are laboratory instruments for electrochemical measurements: **pH**, **conductivity**, **dissolved Oxygen** and **temperature**. They are fitted with a large backlit LCD display.

The **HD2259.2** measures **pH**, **mV**, **redox potential** (ORP) using pH, redox electrodes, separate reference electrodes or combined pH/temperature probes complete with SICRAM module; **concentration of dissolved Oxygen** in liquids (mg/l), **saturation index** (%) and **temperature** using SICRAM combined probes of **polarographic**, with two or three electrodes, and **galvanic** type with integrated temperature sensor.

The **HD22569.2** measures **pH**, **mV**, **redox potential** (ORP) using pH, redox electrodes, separate reference electrodes or combined pH/temperature probes complete with SICRAM module; **conductivity**, **liquid resistivity**, **total dissolved solids (TDS)** and **salinity** using combined 4-ring or 2-ring conductivity/temperature probes with direct input or SICRAM module; **concentration of dissolved Oxygen** in liquids (mg/l), **saturation index** (%) and **temperature** using SICRAM combined probes of **polarographic**, with two or three electrodes, and **galvanic** type with integrated temperature sensor.

The instruments have an input for the immersion, penetration or contact **temperature** probes. The sensor can be a Pt100 or Pt1000.

- The pH electrode calibration can be carried out on one or five points, and the calibration sequence can be chosen from a list of 13 buffers. The temperature compensation can be automatic or manual.
- The calibration of the conductivity probe can be automatic, by recognition of standard solutions: 147 $\mu$ S/cm, 1413 $\mu$ S/cm, 12880 $\mu$ S/cm, 111800 $\mu$ S/cm or manual with different solutions.
- The dissolved Oxygen probe's quick calibration function guarantees timely accuracy of the performed measurements.
- The pH, conductivity, dissolved Oxygen and temperature probes are fitted with a SICRAM module, with the factory calibration settings already being memorized inside.

The devices of the HD22... series are **dataloggers**. They memorize up to 2,000 samples of:

- pH or mV, dissolved Oxygen concentration, saturation index, and temperature for the HD2259.2,
- pH or mV, conductivity or resistivity or TDS or salinity, dissolved Oxygen concentration, saturation index, and temperature for the HD22569.2.

The data can be transferred from the instrument connected to a PC via the RS232C serial port or the USB 2.0 port. The recording parameters can be configured using the menu.

The RS232C serial port can be used for direct printing of the data using a 24 column printer (HD40.1).

The **DeltaLog11** dedicated software allows management and configuration of the instrument, and data processing on the PC.

**The instruments have IP66 protection degree.**

**If not otherwise specified, the description in this manual is intended to be applicable to all models.**

## DISPLAY DESCRIPTION

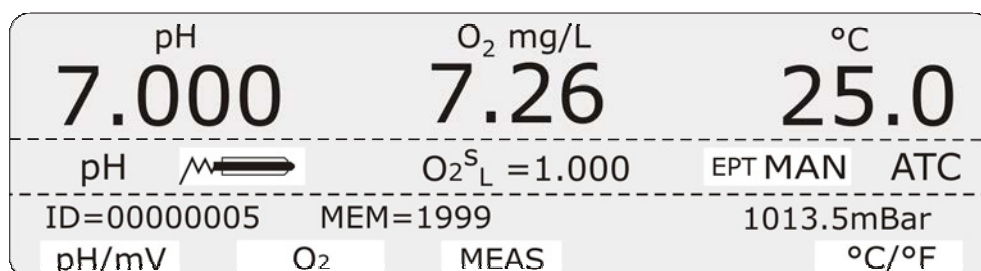

**HD2259.2**

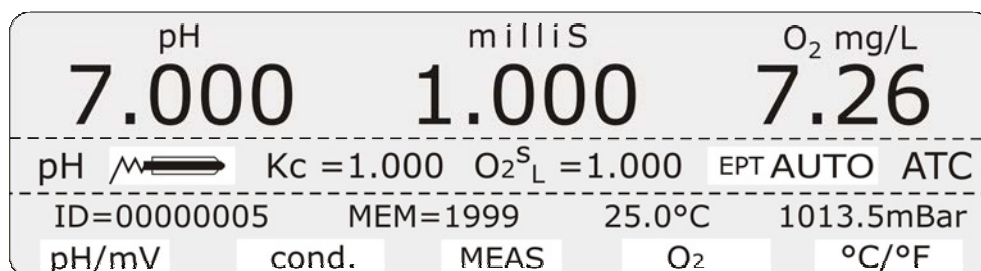

**HD22569.2**

The above appears when you turn the instrument on.

The display is backlit. The contrast level is adjusted using CONTRAST+ and CONTRAST-.

The display has three lines described below:

### *First line*

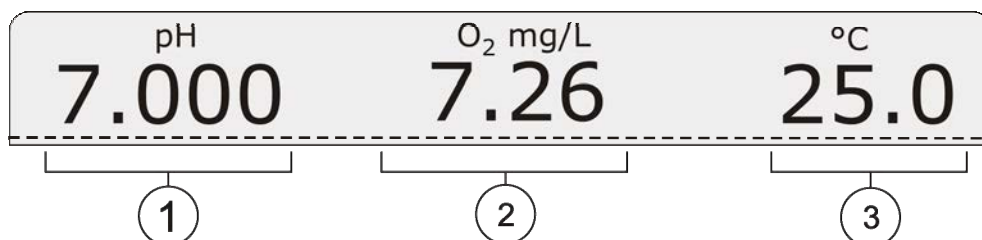

**HD2259.2**

It indicates, from left to right:

1. The pH or mV value measured by the electrode connected to the BNC input ①, or by the SICRAM pH/temperature probe connected to the input ③,
2. The dissolved Oxygen concentration value (mg/l) or the saturation index (%) measured by the SICRAM probe connected to the input ⑥,
3. The temperature value used to compensate the pH and/or dissolved Oxygen measurements (for a detailed description, see the chapter dedicated to temperature on page 43).



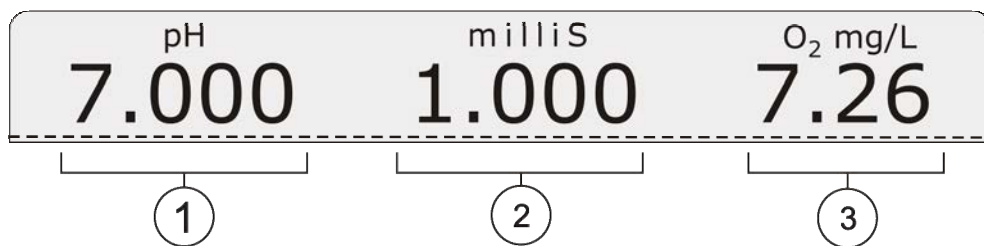

**HD22569.2**

It indicates, from left to right:

1. The pH or mV value measured by the electrode connected to the BNC input ①, or by the SICRAM pH/temperature probe connected to the input ③,
2. The conductivity, resistivity, TDS, NaCl concentration measured by the conductivity probe, **with SICRAM module**, connected to the input ⑦, or by the direct probe, **without SICRAM module**, connected to the input ⑧,
3. The dissolved Oxygen concentration value (mg/l) or the saturation index (%) measured by the SICRAM probe connected to the input ⑥.

*Central line*

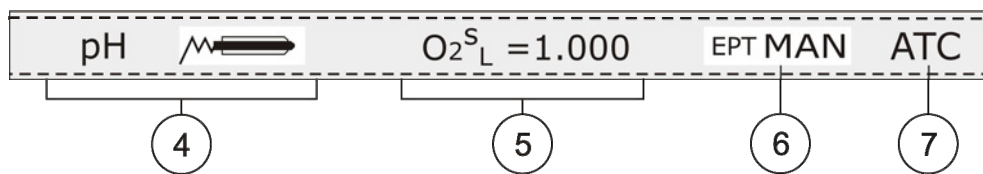

**HD2259.2**

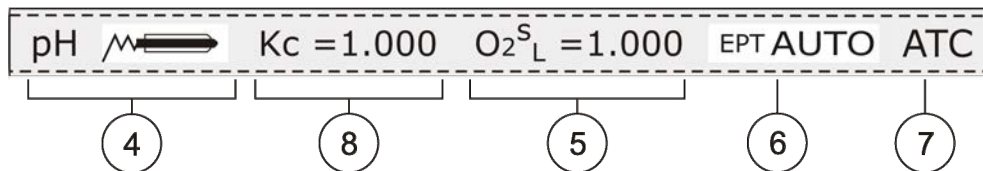

**HD22569.2**

It indicates, from left to right:

4. The symbol indicates the quality of the pH electrode connected to the inputs ① or ③, or the CAL blinking message if the probe connected to the pH input is not calibrated. The symbol shows an electrode that gets “empty” as its efficiency decreases.
5. The dissolved Oxygen probe calibration coefficient (SLOPE): this value must be between 0.500 and 1.500. A value close to 1.500 indicates an exhausted probe.
6. The **EPT** (End Point) symbol indicates the display mode. The mode selection is done using the **ENDPNT** function key (**SHIFT/FNC** key >> **F4** key). When EPT is blinking, the measurement is updated on the display; when it is fixed, the measurement is “frozen”. For a new measurement, press F3 = MEAS.

EPT = **DIR**: the instrument operates in **continuous view mode**. In this mode the displayed measurement is updated every second (standard mode).

EPT = **MAN**: the displayed measurement is continuously updated until **F3 = MEAS** is pressed. During the measurement update, the EPT-MAN symbol is blinking. For a new measurement, press MEAS.

EPT = **TIME**: the measurement is frozen after a set time of 8 seconds. For a new measurement, press MEAS.

EPT = **AUTO**: the instrument performs the measurement, and when it stabilizes the EPT-AUTO symbol stops blinking. For a new measurement, press MEAS.

In the following figure you can see an example of the measurement process with the **EPT AUTO** function enabled. After setting the EPT = AUTO function using the F4 key, the electrode is immersed into a liquid. To perform the measurement, press MEAS. the EPT symbol blinks to indicate that the measurement is in the stabilization phase. In the position indicated by point 1, the measurement remains within a predefined stability range for 8 seconds. At the end of this interval (point 2), the instrument freezes the measurement, and shows a stable value. The EPT AUTO symbol stops blinking.

For a new measurement, press MEAS.

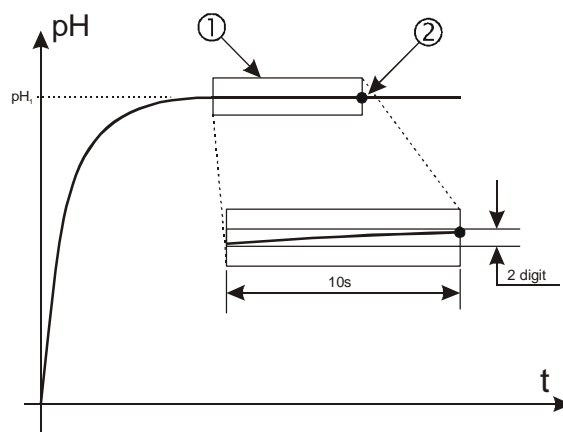

The reference stability range has a span of 2 digits.

When recording is started (Logging), the ENDPNT function switches automatically to DIR.

7. ATC or MTC indicate the temperature compensation type being used.
 

**ATC** means automatic compensation: if the temperature probe is present, compensation is carried out according to this probe, or according to the temperature detected by a combined probe, if present. In this case, you cannot modify the manually input temperature value.

**MTC** means manual compensation: there are no temperature sensors; the temperature used for compensation is typed using the keyboard. Press the “F5 - °C/°F” key once to modify its value: the message ③ blinks. Use the ▼ and ▲ arrows to set the desired value and confirm with ENTER. The display stops blinking, and the temperature displayed is used for compensation.

If the temperature probe is not present, in order to change the unit of measurement between °C and °F, it is necessary to press the F5 = °C/°F key **twice**.
8. In the HD22569.2 instrument, the cell constant value of the conductivity probe connected to inputs ⑦ or ⑧. It has up to 4 different calibration points and nominal cell constant corrections. **The displayed value is referred to the calibration point at 1413µS/cm.**

**Bottom line**

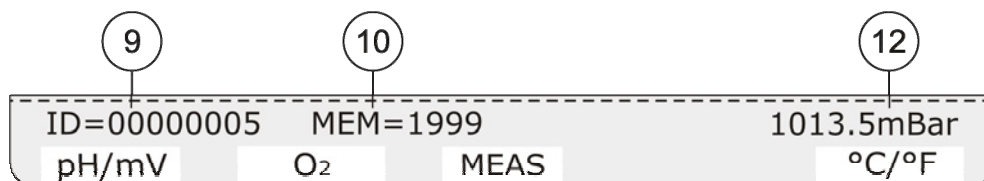

**HD2259.2**

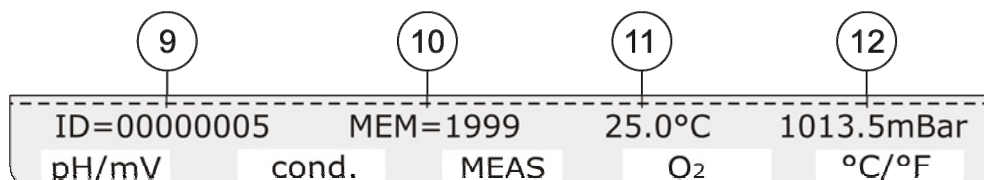

**HD22569.2**

The following is reported in the bottom line:

9. **Identifier ID of the sample being measured:** the automatically increased progressive number associated with the PRINT and MEM functions. The identifier is indicated in the printout and in the recorded samples together with the date, time and measured values.  
To set the number associated to the first sample, press **ID**, then use the ▼ and ▲ arrows to select the desired number: confirm by pressing ENTER. This parameter can be modified only by the administrator (see page 22).  
If the *EPT* option is set to *DIR* (see point 6 in this chapter), each time the PRINT or MEM key is pressed, the identification **ID** is increased by 1.  
If the *EPT* option is set to *Auto, Man or Time*, pressing PRINT only causes the print to occur when the measurement has stabilized (*EPT* symbol still); until the measurement is frozen, it is possible to repeat the print at will, but the sample identifier number is not increased. This is useful when more labels concerning a single measurement must be printed with the same identification code, without increasing the code each time.
10. **MEM** reports the number of samples contained in the instrument's memory.
11. (*Only for HD22569.2*) Temperature value used to compensate the pH, conductivity and dissolved Oxygen measurements.
12. The barometric pressure measured by the internal pressure sensor, expressed in mbar.

By pressing ENTER when the instrument is in standard mode, the current date (in year – month – day format) and time (in hour – minutes – seconds format) are displayed in the third line.

## Function keys

The bottom line is associated to the **F1**, ..., **F5** function keys. When you turn the instrument on, the following messages appear.

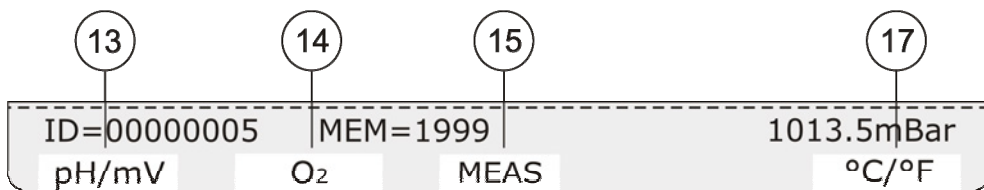

**HD2259.2**

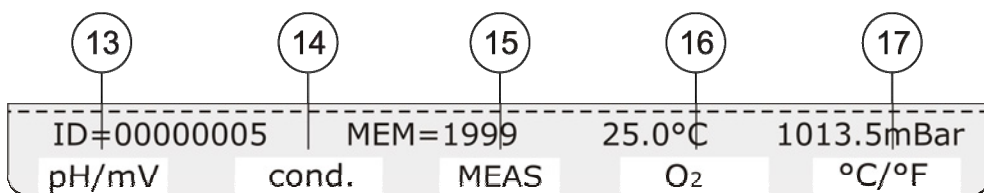

**HD22569.2**

13. **F1.** If you press it repeatedly, it changes the unit of measurement of the electrode connected to the BNC input ① or of the SICRAM pH probe connected to the input ③ between pH, mV, or no indication.
14. **F2.** *HD2259.2 Model* - If you press it repeatedly, it changes the measurement performed on the SICRAM probe connected to the input ⑥, between dissolved Oxygen concentration in liquids (mg/l), saturation index (%), or no indication in absence of the connected probe.  
*HD22569.2 Model* - If you press it repeatedly, it changes the measurement performed on the probe connected to the input ⑦ (SICRAM probe) or input ⑧ (direct probe without SICRAM), between conductivity, resistivity, TDS, NaCl concentration, or no indication.
15. **F3.** Allows to repeat the measurement, when the EPT = AUTO, MAN or TIME modes are selected.
16. **F4.** *HD22569.2 Model* - If you press it repeatedly, it changes the measurement performed on the SICRAM probe connected to the input ⑥, between dissolved Oxygen concentration in liquids (mg/l), saturation index (%), or no indication in absence of the connected probe.
17. **F5** = °C/°F: if the temperature sensor is present, the key changes the unit of measurement between °C and °F. If no temperature or combined temperature probes are present, the key allows manual input of the temperature value used for compensation and of the unit of measurement (°C or °F). See also point 7.

By pressing the **SHIFT/FNC** key, you can access the secondary functions linked to the F1, ..., F5 function keys.

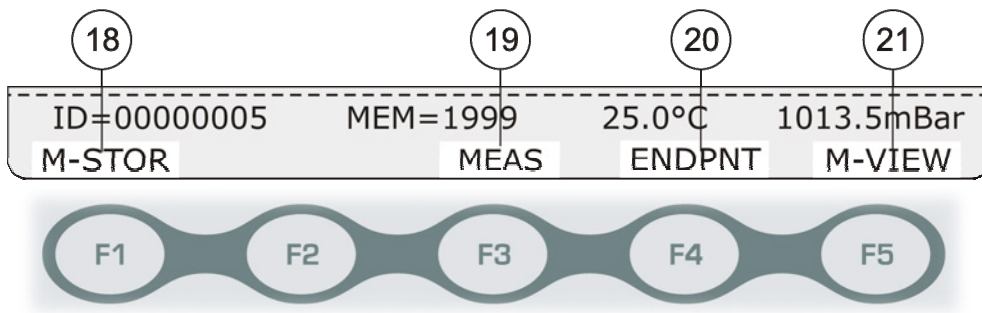

18. **F1 = M-STOR** - Stores the current information. It performs the same function as the MEM key.  
When EPT is different from DIR (see point 6), the logging is disabled until the measurement is stable: M-STOR is displayed only when the measurement is stable.
19. **F3 = MEAS** - Allows to perform or repeat a new measurement, when the EPT = AUTO, MAN or TIME modes are selected (see point 6).
20. **F4 = ENDPNT** - Selects the displayed measurement update mode (see point 6)
21. **F5 = M-VIEW** - Allows to display the stored data or to clear the memory. See the details on page 53.

## KEYBOARD DESCRIPTION

Each key specific function is described in detail below.



### ON-OFF key

The instrument is turned on and off using the ON/OFF key. **Press this key for at least two seconds.** A subsequent press of the ON-OFF key sets the instrument in standby mode: the message “STANDBY” scrolls on the display.

The turning on starts a self test including the detection of the probes connected to the inputs. **As the probes' identification and calibration data are captured upon turning the instrument on, it is necessary to connect them when the instrument is off. If a probe is connected and the instrument is on, it is necessary to turn it off and on.**

Finally, the instrument is set for normal measurement.

**Once turned off (standby), wait few seconds before turning it on** to allow completion of the shut down routine.

**The instrument enters standby mode only by pressing the ON\_OFF key:** if the power supply is removed and then applied again, the instrument does not enter standby mode, but remains completely off: in this case a dissolved oxygen probe connected to the instrument is not powered until the instrument is turned on with the ON-OFF key.



### PRINT key

It sends the displayed data to the serial RS232C or USB output.

If EPT = DIR, the identification **ID** is increased by 1 (see page 12).

Before starting the communication via the RS232C serial port, set the baud rate. To do so, select “*System Parameters >> RS232 Speed (Baud Rate)*” and select the maximum value equal to 115200 baud by using the arrows ▲ and ▼. Confirm by pressing ENTER.

The DeltaLog11 software for PC will automatically set the baud rate value during connection by reading it on the instrument. **If you are using a different program than DeltaLog11, be sure the baud rate is the same for both the instrument and the PC: the communication will only work in this way.**

If the instrument is connected directly to a serial printer, set the recommended baud rate for the printer. See the details on page 54.



### CONTRAST+ key

This key allows to increase the display contrast.



### CONTRAST- key

This key allows to decrease the display contrast.



...



### Function keys F1, ..., F5

The function of the F1, ..., F5 keys is described by the message near each key in the bottom line of the display. A complete description of these keys is reported on page 13.



### SHIFT/FNC key

The F1...F5 keys have two functions: the main and the secondary functions. By pressing the SHIFT/FNC key, you can toggle between the two functions.

LOG



### LOG key

It starts and stops the logging of a data block to be saved in the instrument's internal memory. The data logging frequency is set in the “*System Parameters >> Logging Options >> Select Log Interval*” menu. The data logged between a start and subsequent stop represent a data block.

When the logging function is on, the “*NOW LOGGING!*” indication is displayed. Upon each recording, the identification ID and the MEM counter are increased by 1 (see page 12).

To end the logging, press LOG.

For the details see the chapter dedicated to recording on page 53.

ID



### ID key

This key allows to input the value of the first sample ID associated with the PRINT function. Use the ◀ and ▶ arrows to select the value to be modified, and set the desired value using the ▲ and ▼ arrows. Modify the other values in the same way. At the end, confirm with ENTER. For the details, see the description on page 12.

This parameter can be modified only by the administrator (see page 22).





### **HELP key**

It displays a short help on the instrument's main functions. Press ESC to go back to standard measurement. Use ENTER to browse the HELP items.



### **CAL key**

Starts the pH electrodes, conductivity probe or dissolved Oxygen probe calibration procedure (see the chapter dedicated to calibration on page 26).



### **ENTER key**

In the menu, the ENTER key confirms the current parameter. During measurement, The ENTER key displays the current date and time in the central line for few seconds.



### **ESC key**

In the menu, the key clears or cancels the active function.



### **MEM key**

It stores the displayed data.

The data refer to the following measurements:

- pH, mV, dissolved Oxygen concentration, saturation index, and temperature for the HD2259.2;
- pH, mV, conductivity, resistivity, TDS, NaCl, dissolved Oxygen concentration, saturation index, and temperature for the HD22569.2.

The units of measurement are those selected on recording with the F1 and F2 function keys for HD2259.2, F1, F2 and F3 for HD22569.2. For the details see the chapter dedicated to recording on page 53.



### **SETUP key**

Using this button the instrument's menu can be accessed. See a detailed description on page 18.

## MENU DESCRIPTION

The SETUP key is used to access the menu main screen. To select one item, use the arrow keys (▲ and ▼).

Press ENTER to access the selected item. Use the ▲ and ▼ arrows to browse the submenus and modify the single parameters. Press ENTER to confirm the value of the selected parameter, press ESC to cancel the operation: in both cases, you return to the initial menu.

Press ESC to return to the main menu from a submenu, and to exit the main menu and return to measurement mode.

Note: some parameters can be changed only by an user registered as “Administrator” (see the details on page 22).

### *Language selection*

The menu items are in 4 languages: Italian, English, French and Spanish. To select the language, press SETUP, use the ▲ and ▼ arrows to select “Languages / Users / Passwords” >> “User Registration” and select the language using the SETUP key. Press ESC to confirm and return to measurement mode.

The menu items are listed in this order:

#### 1. “**INFORMATION / STATUS / HELP**”

- 1.1. “*Instrument Info*” shows some information for the instrument: model, types of measurement, firmware version, serial number and calibration date.
- 1.2. “*Instrument Status*” reports the last enabled user, the current type and status of communication interface, the temperature compensation mode and the temperature sensor used for compensation.
- 1.3. “*Short Reference Manual*”. It is a short help showing the instrument main functions.

#### 2. “**LANGUAGE / USERS / PASSWORDS**”

- 2.1. “*User Registration, current...*” selects the language among Italian, English, French or Spanish and/or the current user type. See the details on page 22.
- 2.2. “*Create / Edit User Password*” allows to create and/or edit the password associated to each registered user: Administrator, User\_1, User\_2 and User\_3. See the details on page 22.
- 2.3. “*User Exit Mode*”: when you turn the instrument on you can get:
  - A) The user of the previous session without requiring a password (“Recall User”),
  - B) Require a user (“Forget User”): in this case, you have to select the user and, if not “Anonymous”, enter the password. This parameter can be modified only by the administrator (see page 22).
- 2.4. “*Instrument Identifier*” allows input of a code to identify the instrument. This will be included in the printouts and in the stored data. Use the *F1= Back* and *F4= Forward* to move the character insertion point, select the single character on the right using the ▲ ▼ ◀ ▶ arrows, confirm using ENTER. Press *F3=Finish* to save the code and exit. Press ESC to exit without making changes. The instrument identification parameter can be modified only by the administrator (see page 22).

### 3. “SYSTEM PARAMETERS”

- 3.1. “*Date and Time*” – This function manages the instrument date and time setting. Use the ◀ and ▶ arrows to move the cursor, and the ▲ and ▼ arrows to edit the selected value. The SETUP key clears the seconds to synchronize them to the minute: use the ▲ and ▼ arrows to set the current minute plus one, and as soon as that minute is reached press SETUP. This synchronizes the time to the second. Press ENTER to confirm, ESC to exit without making changes.
- 3.2. “*Memory and Logging Options*” is composed of three sub-functions:
  - 3.2.1. “*Sampling Interval*”: sets the interval in seconds between two loggings. The interval can be set from 0 to 999 seconds. **If the value 0 is set, the logging is disabled.** Press LOG to start the logging, press LOG again to end.
  - 3.2.2. “*Storage Mode*”: selects the instrument memory management mode.
    - By setting it to “0” you select the standard mode (normal): when the memory is full, the logging stops; to carry out further recordings, you should download the data, if necessary, and clear them.
    - By setting it to “1” you select the cyclic mode (endless loop): when the memory is full, it starts to overwrite the oldest data. Recording is not interrupted. The logging mode can be selected or modified only by the administrator (see page 22).
  - 3.2.3. “*Print and Storage Mode*”:
    - If you select “0”, when using PRINT the current data is sent to the printer but is not saved in the memory.
    - If you select “1”, when using PRINT the current data is sent to the printer and also saved in the memory.This parameter can be selected only by the administrator (see page 22).
- 3.3. “*Select the Baud Rate of the serial communication*”. This function allows selection of the frequency used for the serial RS232 communication with the PC. Values from 1200 to 115200 baud. Use the ▲ and ▼ arrows to select the parameter and confirm with ENTER. **The communication between instrument and PC (or serial port printer) only works if the instrument and PC or printer baud rates are the same.** If the USB connection is used this parameter value is automatically set (please see the details on page 53).
- 3.4. “*Electrode Serial Numbers*”. It identifies the serial numbers of the SICRAM probes connected to the inputs, and allows to type in the serial numbers of the pH electrodes and probes without SICRAM automatic detection module. These serial numbers are reported in the printouts and stored data.

The SICRAM pH, conductivity and dissolved Oxygen probes report the “Service hours”, that is, the number of hours that the probe has been connected to the functioning instrument. This parameter is saved in the SICRAM memory and cannot be modified.
- 3.5. “*System Reset*” It is formed by two sub-functions:
  - 3.5.1. “*Partial System Reset*”: the partial reset restores the instrument functioning without modifying the functioning parameter settings such as, Baud Rate, log interval, date and time,... The data in the memory are not cleared. This operation can be carried out only by the administrator (see page 22).
  - 3.5.2. “*Complete System Reset*”: the complete system reset restores the instrument to the original factory conditions, restoring all menu parameters. After a complete reset, the date, time, baud rate, log interval,... must be set again. The data in the

memory are not cleared. This operation can be carried out only by the administrator (see page 22).

#### 4. “MEASUREMENT AND pH CALIBRATION OPTIONS”

- 4.1. “*pH Resolution*”: selects the number of leading digits for the pH measurement. Using the ▲ and ▼ arrows, select 7.12 to obtain the pH hundredths or 7.123 to obtain the thousandths. The chosen resolution is applied to the new logged measurements, while the previous choice still applies for the already memorized ones.
- 4.2. “*pH Buffer Solutions*”: the instruments allows selecting up to 5 buffers for the pH electrode calibration. Press F1, ..., F5 to select BUFFER1, ..., BUFFER5, respectively. Use the ▲ and ▼ arrows to select the value to be assigned to the chosen buffer. You can select one of the 13 buffers in the memory, enter a user defined CUSTOM buffer, or exclude one from the list by selecting NIL. The 13 buffers in the memory are compensated for temperature, but the buffer defined by the user is not compensated for temperature: so the buffer value must be set at the actual solution temperature. As an alternative, the correct value according to temperature can be set in the calibration phase. Please see the chapter dedicated to calibration on page 26.
- 4.3. “*pH Electrode Calibration History*”: the last eight calibrations on each input channel (BNC or SICRAM) can be stored in the memory. The data are associated to the electrode serial number: for a SICRAM probe, the serial number is read from its memory, otherwise it must be entered in “System Parameters” >> “Electrode Serial Numbers”. The “*Show pH Electrode Calibration History*” submenu displays the following: date, time, operator that carried out the calibration, calibration points (pH, mV and temperature detected). The last 8 calibration information are shown: offset, slope and the symbol indicating the pH electrode efficiency after calibration. Use the ▲ and ▼ arrows to browse the last 8 calibrations. Use the “*Print pH Electrode Calibration History*” function to print the information.
- 4.4. “*Electrode Calibration Expiration*”: it is possible to set the pH electrode calibration validity number of days. When the validity period has expired, the “CAL” blinking message appears; the calibration data are still used. The “Expired calibration” message is indicated in the printout. Enter “Number of days” = 0 to disable this feature.  
Note: the day is counted at midnight. By entering 1, at midnight of the same day, the calibration is considered expired.  
This operation can be carried out only by the administrator (see page 22).
- 4.5. “*Clear Calibration History*”: this function clears the pH electrode calibration information (see “*pH Electrode Calibration History*” above). Press ENTER to erase, ESC to exit without erasing.  
This operation can be carried out only by the administrator (see page 22).

#### 5. “CONDUCTIVITY MEASUREMENT OPTIONS”

- 5.1. “*ALFA Coefficient*” ( $\alpha_T$ ): the temperature coefficient  $\alpha_T$  is the percentage measurement of the conductivity variation according to temperature and is expressed in %/°C (or %/°F). The admitted values vary from 0.00 to 4.00%/°C. Use the arrows (▲ and ▼) to set the desired coefficient, and confirm with ENTER.
- 5.2. “*Conductivity Reference Temperature*”: it indicates the temperature to which the displayed conductivity value is standardized. The values vary from 0 to 50°C. **Usually**

**the values of 20°C or 25°C are used.** Use the arrows (▲ and ▼) to set the desired value, and confirm with ENTER.

- 5.3. “*TDS Coefficient*”: it represents the  $\gamma$ /TDS conversion factor, that is, the ratio between the measured conductivity value and the total quantity of dissolved solids in the solution, expressed in mg/l (ppm) or g/l (ppt). This conversion factor depends on the nature of the salts present in the solution. In the field of water quality treatment and control, the main component is CaCO<sub>3</sub> (Calcium Carbonate). A value of 0.5 is usually used. In agriculture, for fertilizer water preparation, and in hydroponics, a factor of about 0.7 is used. Using the arrows (▲ and ▼), set the desired value, selecting it in the 0.4...0.8 range, and confirm with ENTER.
- 5.4. “*Conductivity Cell Nominal Value*”: sets the cell constant nominal value of the conductivity probe without SICRAM. In the SICRAM probe, the cell constant nominal value is detected directly by the instrument and cannot be modified. The 0.01, 0.1, 0.5, 0.7, 1.0 and 10cm<sup>-1</sup> are prompted, or a value between 0.01 and 20. **The cell constant must be inserted before starting the probe calibration.** The cell constant change entails resetting the calibration date: the new calibration updates the calibration date.

## 6. “DISSOLVED OXYGEN MEASUREMENT OPTIONS”

- 6.1. “*Show Dissolved Oxygen Probe Calibration History*”: the dissolved Oxygen probe SICRAM module stores the last eight calibrations in the memory. This menu item displays each calibration date and slope. The “*Print Dissolved Oxygen Probe Calibration History*” function, gives the date, slope and temperature per each calibration.
- 6.2. “*Dissolved Oxygen Probe Calibration Expiration*”: it is possible to set the dissolved Oxygen probe calibration validity number of days. When the validity period has expired, the “CAL” blinking message appears; the calibration data are still used. The “*Expired calibration*” message is indicated in the printout. Enter “Number of days” = 0 to disable this feature.  
Note: the day is counted at midnight. By entering 1, at midnight of the same day, the calibration is considered expired.  
This operation can be carried out only by the administrator (see page 22).
- 6.3. “*Clear Calibration History*”: this function clears the dissolved Oxygen probe calibration information (see “*Dissolved Oxygen Probe Calibration History*” above). Press ENTER to erase, ESC to exit without erasing.  
This operation can be carried out only by the administrator (see page 22).
- 6.4. “*Manual Setting of the Salinity*”: enter the measured liquid salinity. Use the ▲ and ▼ arrows to set the value expressed in g/l, and confirm with ENTER. To disable the salinity compensation, set the value to zero.  
Note: the dissolved Oxygen concentration depends on the measured liquid salinity. In contrast, salinity has no effect on the saturation index.
- 6.5. “*Automatic Correction of the Salinity*”: the salinity value is measured directly by the instrument, if a conductivity probe is connected and immersed in the measured liquid. Select “0” to manually set the correction using the “*Manual Setting of the Salinity*” menu item, select “1” to enable automatic correction.

## USER MANAGEMENT

The user must identify himself or herself by entering a user name and password: the registered user name is shown in all performed operations: printing, logging, calibration...

The available users are: *administrator*, *user\_1*, *user\_2*, *user\_3* and *anonymous user*. The different users have different usage levels: the *Administrator* is enabled to use all of the instrument functions and assigns the password to the other users. The three users and the anonymous can access only part of the functions.

### Parameter Setup

The user management options are stored in the “**LANGUAGE / USERS / PASSWORDS**” menu item.

When the instrument comes out of the factory, the only user stored is the administrator. The password is “00000000”: the “*Create / Edit User Password*” function allows modification of the administrator password.

To enable *user\_1*, *user\_2* and *user\_3*, you must assign a different password (not “00000000”), using the “*Create / Edit User Password*” function.

In order to do that:

1. Select the menu item “*Create / Edit User Password*”.
2. Select the user (e.g. *User\_1*) using the ▲ ▼ ◀ ▶ arrows.
3. Type the old password (“00000000” in the new instrument), and confirm with ENTER.
4. Type the new password (not “00000000”), and confirm with ENTER.
5. Select “**LANGUAGE / USERS / PASSWORDS**” >> “*User Registration, current = Administrator*” using the ▲ ▼ ◀ ▶ arrows, and select the new user to which you have just assigned a password.
6. Type the password, and confirm with ENTER.

Now *User\_1* is enabled and can use the instrument: the printed and stored information will show “Operator = *User\_1*”.

Note: the passwords beginning with 27 (27000000 to 27999999) are reserved and you cannot use them.

### Access modes

If you wish the instrument to request the user selection and relevant password upon turning on, set “*User Exit Mode*” = *Forget User*. When you turn the instrument on you get all the users: select the user using the ▲ ▼ ◀ ▶ arrows, and type its password. Confirm by pressing ENTER. The anonymous user does not need a password.

If you select “*Recall User*”, the instrument uses the previous user without requiring a password. In this case, use the “*User Registration, current...*” menu item to change the user (see points 5 and 6 above).

Note: the access mode can be modified only by the administrator.

### Functions reserved to the administrator

Some functions are reserved to the user registered as “Administrator” (see the details on page 18).

Only the Administrator can:

- modify the instrument identifier,

- perform the instrument partial and total reset,
- set the *user exit mode* (“*User Exit Mode*”),
- selects the instrument memory management mode (“*Storage Mode*”),
- set the storage mode when using the PRINT key (“*Print and Storage Mode*”),
- clear the calibration history (“*Clear Calibration History*”),
- set the pH and dissolved Oxygen calibration interval (“*Electrode Calibration Expiration*” and “*Dissolved Oxygen Probe Calibration Expiration*”),
- modify the ID sample value (ID key),
- clear the memory (see the paragraph on page 54).

## PH MEASUREMENT

The HD2259.2 and HD22569.2 instruments work with pH/temperature probes complete with SICRAM module, pH measurement electrodes, redox potential measurement electrodes (ORP), and specific ion electrodes. The pH measurement is generally accompanied by the temperature measurement. The SICRAM combined pH/temperature probes are fitted with Pt100 temperature sensor: the instruments measure also the temperature using probes fitted with 4 wire Pt100, or 2 wire Pt1000 sensors, or using probes complete with SICRAM module. The temperature is used for the automatic compensation of the Nernst coefficient with the pH electrode.

If a temperature only probe is connected (connector ⑤), it has priority on the temperature supplied by any combined probe: please see the chapter dedicated to temperature measurement on page 43.

### *Probes with SICRAM and without SICRAM*

The SICRAM pH probe is formed by a pH electrode, a Pt100 temperature sensor and an electronic module. The module has a memory circuit that enables the instrument to recognize the type of probe connected. It stores also the serial number, the factory calibration of the Pt100 sensor, the manufacturing date and the parameters of the last two pH calibrations performed by the user.

The instrument stores the last eight pH calibrations performed by the user: the last two calibrations are stored in the probe's SICRAM memory. Upon power on, the instrument reads the two calibrations in the probe and, if the probe was calibrated on the same instrument, they are added to the ones already stored in the instrument in order to make up the history calibration of the SICRAM pH probe. If the SICRAM pH probe is connected to a different instrument, only the parameters in the probe memory will make up the calibration history.

**If a SICRAM pH probe is connected to the instrument, the relevant BNC direct input is disabled:** the SICRAM pH probe has priority on the electrode connected directly to the BNC input.

### *Module pH SICRAM KP47*

The KP47 module is a SICRAM type interface for pH electrodes with BNC connector. By using this module you can add all of the advantages of a SICRAM probe to a pH electrode: for example, you can move the module linked to the electrode from an instrument pH SICRAM input to a second instrument, without performing a new calibration.

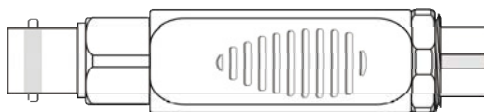

The module is automatically recognized by the instrument when you turn it on, and the serial number and parameters described above are read.

You just need to connect the electrode to the module female BNC connector, connect the module to the pH SICRAM input ③, and turn on the instrument. Perform a first calibration on two or more points. One must be in the neutral band (e.g. 6.86pH). The module is now ready for use.

Of course, once the calibration is performed, the electrode linked to the module should not be changed: as the electrode calibration information are saved in the module, this will generate measurement errors. When you replace the electrode you should do a new calibration.



## The electrode for pH measurement

The electrode for pH measurement, generally in glass, generates an electrical signal proportional to the pH according to Nernst law. Of this signal the following aspects are considered:

**Zero point:** the pH where the electrode generates a potential of 0 mV. In most electrodes, this value is found at about 7 pH.

**Offset or Asymmetry Potential:** mV generated by an electrode when immersed in a buffer solution at 7pH. Generally oscillates between  $\pm 20$  mV.

**Slope:** response of the electrode expressed in mV per pH units. The theoretical electrode slope at 25°C is 59.16 mV/pH. When the electrode is new the slope is close to the theoretical value.

**Sensitivity:** it is the electrode's slope expression in relative terms. It is obtained by dividing the actual value of the slope by the theoretical value, and is expressed as a %. The asymmetry potential and the slope vary in time with the use of the electrode, which necessitates regular calibration.

The pH electrodes must be calibrated using the standard solutions (see the calibration chapter below). The ORP and specific ion electrodes do not need calibration. **The standard redox solutions are only used to check the quality of a redox electrode.**

**User calibration of the temperature sensor is not required: the sensor is calibrated in the factory and the Callendar Van Dusen parameters are recorded in the SICRAM module.**

**The probes are detected during turn on, and this cannot be performed when the instrument is already on, therefore if a probe is connected and the instrument is on, it is necessary to turn it off and on.**

### Automatic or manual temperature compensation for pH measurement

The pH measurement is influenced by the measured solution temperature.

The electrode slope varies according to the temperature in a known mode according to Nernst law: e.g., a 1pH variation, that at 25°C means 59.16mV, at 100°C means 74.04mV.

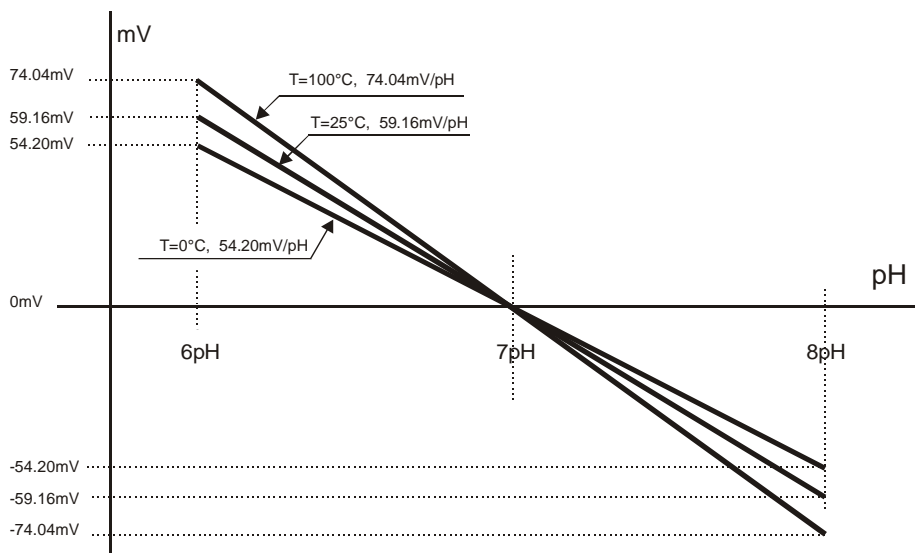

When a temperature probe is present (temperature only probe, combined pH/temperature probe or conductivity/temperature probe), the instrument automatically applies the **ATC** (Automatic Temperature Compensation) function.

In absence of the temperature probe or sensor, the lower display shows the **MTC** (Manual Compensation Temperature). If the correct value is not entered manually, the extent of the error committed in pH measurement is proportional to temperature and measured liquid pH value itself.

In **MTC** mode, in order to manually change the compensation temperature press **F5=°C/°F** once: the indicated temperature value starts blinking. Select the desired temperature value by using the **▲**

and ▼ arrows, and confirm with ENTER. The display stops blinking, and the temperature displayed is used for compensation.

**During manual compensation, in order to change the unit of measurement between °C and °F, it is necessary to press the °C/°F key twice.**

### pH electrode calibration

The electrode calibration is used to compensate the asymmetry potential and slope departures to which the electrode is subject with time.

The calibration frequency depends on the accuracy desired by the user and on the effects that the measured sample has on the electrode. Generally, we recommend daily calibration, but it is the user's responsibility from personal experience, to establish the most appropriate frequency.

The calibration may be carried out using one or more points (up to 5): when using 1 point, the electrode offset is corrected, with 2 points the offset and the gain is corrected.

The instrument has a memory of 13 buffers with relevant temperature compensation tables (ATC) plus a "CUSTOM" buffer, not compensated for temperature. The five buffers can be selected by using the **BUFFER\_1, ..., BUFFER\_5** menu items. Usually two for the acid, one for the neutral, and two for the alkaline band will be selected:

@25°C

BUFR_1 (NEUTRAL)	<b>6.860</b>	6.865	7.000	7.413	7.648
BUFR_2 (ACID)	1.679	2.000	4.000	4.008	<b>4.010</b>
BUFR_3 (ALKALINE)	<b>9.180</b>	9.210	10.010		

If electrode calibration was not carried out on the instrument, or the last calibration failed, the display blinks the **CAL** message.

### Calibration procedure

1. Select the buffers in the "*Measurement and pH Calibration Options*" >> "*pH Standard Solutions*" menu item (please see the menu description on page 18). This operation must be performed only the first time or when the normal calibration buffers are changed.
2. Insert the SICRAM pH/temperature probe or the electrode and temperature probe in the solution of the selected calibration buffer. If no temperature probe is available, use a thermometer and enter the value manually as indicated in the paragraph "*Automatic or Manual pH Compensation*".
3. The electrode calibration mode is started by pressing **CAL**.
4. Select the pH input connected to the electrode being calibrated.
5. Among the three prepared buffers, the instrument automatically detects the closest to the pH value being read, and shows the nominal value at 25°C on the right with a blinking arrow.

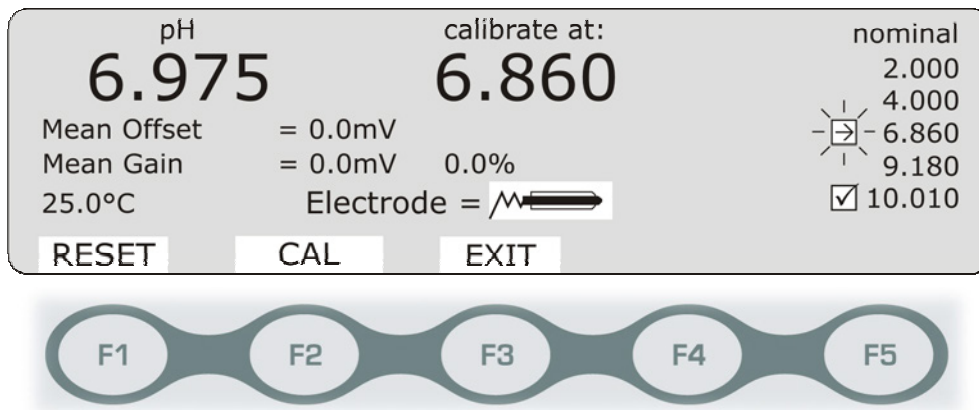

The display shows on the left the current pH measurement value according to current calibration. The buffer value compensated for temperature is displayed in the center. The detected and temperature compensated buffer value, shown in the center, can be modified using the arrows  $\blacktriangledown$  and  $\blacktriangle$ .

6. To proceed with the calibration press **F2 = CAL**. The offset and gain calibration and the electrode efficiency are displayed. The blinking arrow changes to  to indicate that the current value has been accepted. The blinking means the instrument is still in calibration mode. By pressing F2 = CAL again, it is possible to repeat the calibration from the last point to obtain a finer calibration.
7. Extract the electrode from the buffer, wash it, clean it carefully, and insert it in the following buffer.
8. The instrument shows the new buffer value with the blinking arrow. **The previous calibration point is captured permanently:** the blinking , becomes still.
9. Continue with other calibration points, by repeating the steps from point 6.
10. To end the electrode calibration, press **F3 = EXIT**.

## NOTES

- **By accessing the pH calibration, the previous calibration information are transferred in the “pH Electrode Calibration History”. The current offset and slope values are set to nominal values: the offset = 0mV, the gain varies according to the measured temperature (59.16mV/pH at 25°C). You should perform a new calibration.**
- If an error is made during calibration, you can press F1 = RESET to restart with a new calibration.
- The instrument is provided with a measurement stability control system: until the reading is not sufficiently stable, the F2 = CAL key is disabled. Instead, the WAIT message is displayed.
- When choosing the standard buffer (see the MENU), you can disable one by selecting **NIL**. In this case, the buffer is excluded from the sequence, and won't be proposed during calibration.
- If the buffer value is rejected because it is considered to be excessively corrupted, the “*Buffer value out of limits!*” message will appear. The instrument waits for a valid buffer. If it is not available, press F1=RESET to restore the initial calibration and exit using F3=EXIT. Repeat the calibration as soon as possible.
- During calibration, the instrument evaluates the electrode efficiency: if the correction is excessive, the electrode symbol is replaced by “ERROR”. If you confirm the calibration anyway, the electrode symbol blinks during measurement to remind you that you should replace it as soon as possible.

### Temperature characteristics of Delta OHM standard solutions

The 13 standard buffers reported in the table on page 26 are memorized in the instruments with relevant variations according to temperature: the characteristics of the three Delta Ohm standard buffers at 6.86pH, 4.01pH and 9.18pH (@25°C) are reported below.

#### 6.86 pH @ 25°C

°C	pH	°C	pH
0	6.98	50	6.83
5	6.95	55	6.83
10	6.92	60	6.84
15	6.90	65	6.85
20	6.88	70	6.85
<b>25</b>	<b>6.86</b>	75	6.86
30	6.85	80	6.86
35	6.84	85	6.87
40	6.84	90	6.88
45	6.83	95	6.89

#### 4.01 pH @ 25°C

°C	pH	°C	pH
0	4.01	50	4.06
5	4.00	55	4.07
10	4.00	60	4.09
15	4.00	65	4.10
20	4.00	70	4.13
<b>25</b>	<b>4.01</b>	75	4.14
30	4.01	80	4.16
35	4.02	85	4.18
40	4.03	90	4.20
45	4.05	95	4.23

#### 9.18 pH @ 25°C

°C	pH	°C	pH
0	9.46	50	9.01
5	9.39	55	8.99
10	9.33	60	8.97
15	9.28	65	8.94
20	9.22	70	8.92
<b>25</b>	<b>9.18</b>	75	8.90
30	9.14	80	8.88
35	9.10	85	8.86
40	9.07	90	8.85
45	9.04	95	8.83

## CONDUCTIVITY MEASUREMENT

The HD22569.2 works with direct conductivity/temperature probes (input ③), direct 4-electrode and 2-electrode only conductivity probes (input ④), or combined conductivity/temperature probes with SICRAM (input ⑦). The 4 wire Pt100, 2 wire Pt1000 sensors may be used for measuring temperature, which is used for the automatic compensation of the conductivity.

**If a temperature only probe is connected (connector ⑤), the measured temperature becomes the reference value for the measurement system, and has priority on the one supplied by the combined conductivity probe.**

### *Probes with SICRAM and without SICRAM*

The combined conductivity probe with SICRAM is fitted with a Pt100 temperature sensor and an electronic module. The module has a memory circuit that enables the instrument to recognize the type of probe connected. It stores also the serial number, the factory calibration of the Pt100 sensor, the manufacturing date and the last calibration performed by the user.

**The combined conductivity probe with SICRAM is connected to input ⑦, the direct probe without SICRAM is connected to input ④: if the inputs are exchanged, the instrument does not measure and displays 0.0  $\mu\text{S}/\text{cm}$ . If you connect simultaneously two conductivity probes (one with SICRAM and one without SICRAM) to the respective inputs, the displayed measurement is not correct.**

**The conductivity probes with SICRAM use the cell constant stored in their memory, the probes without SICRAM use the cell constant stored in the instrument during calibration.**

**A new calibration updates the cell constant. If the probe is fitted with a SICRAM module, the new cell constant is saved in the probe's memory. If the probe is not fitted with a SICRAM module, the cell constant is saved in the instrument's memory.**

The instrument stores the nominal cell constant entered manually in the menu. If you perform a calibration using a probe without SICRAM, the instrument updates the constant in the memory with the new one resulting from the calibration of the new probe without SICRAM.

If you connect and disconnect a probe with SICRAM, and later you connect a probe without SICRAM, the instrument reloads the cell constant of the last calibration performed using the probe without SICRAM. If the conductivity probe is the one used for the last calibration without SICRAM, the cell constant proposed is correct. If the conductivity probe is different, to obtain a correct measurement you have to manually set the cell constant and perform a new calibration.

**For the direct probes (non SICRAM), the cell constant nominal value must be entered in the “Conductivity Measurement Options” >> “Conductivity Cell Nominal Value” menu item. You cannot modify the cell constant value of a probe with SICRAM directly from the menu.**

The instrument obtains the following from the measurement of conductivity:

- the liquid resistivity measurement ( $\Omega$ ,  $\text{k}\Omega$ ,  $\text{M}\Omega$ ),
- the concentration of total dissolved solids (TDS) according to the  $\chi/\text{TDS}$  conversion factor, which can be modified using the menu,
- the salinity (NaCl quantity in the solution, expressed in g/l).

By repeatedly pressing “**F2 = cond.**” you can select the quantity.

The conductivity probes must be periodically calibrated. To facilitate this operation, four standard calibration solutions are automatically recognized by the instrument:

- 0.001 Molar KCl solution (147 $\mu$ S/cm @25°C),
- 0.01 Molar KCl solution (1413 $\mu$ S/cm @25°C),
- 0.1 Molar KCl solution (12880 $\mu$ S/cm @25°C),
- 1 Molar KCl solution (111800 $\mu$ S/cm @25°C),

**User calibration of the temperature sensors is not required.** The 4-wire and 2-wire probes with direct input **are checked for conformity with class A tolerance** according to norm IEC751 - BS1904 - DIN43760.

**The probes are detected during turn on, and this cannot be performed when the instrument is already on, therefore if a probe is connected and the instrument is on, it is necessary to turn it off and on.**

### *Standard SP06T probe*

The 4-electrode conductivity/temperature combined probe, code SP06T, is delimited by a bell in Pocan.

A positioning key, present in the probe's end part, orients the bell correctly when the probe is introduced. For cleaning, simply pull the bell along the probe's axis **without rotating it. It is not possible to perform measurements without this bell.**

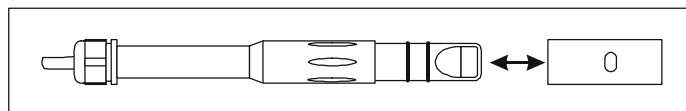

The probe is recommended for non-heavy general use. The temperature measuring range is 0°C...+90°C.

### *4-electrode or 2-electrode probes*

The HD22569.2 uses 4-electrode or 2-electrode probes for conductivity measurement. The selection of the type of probe is automatic.

The 4-electrode probes are preferred to measure high conductivity solutions, either over an extended range or in presence of pollutants. The 2-electrode probes operate in a shorter measurement range but with an accuracy comparable with the 4-electrode probes.

The probes can be in glass or plastic: the first can work in presence of aggressive pollutants, the latter are more resistant to collisions, and so more suitable for industrial use.

### *Probes with temperature sensor*

The conductivity probes fitted with built-in Pt100 temperature sensor, measure conductivity and temperature at the same time: this allows automatic correction of the conductivity (ATC) according to the measured temperature. Alternatively, you can measure the temperature using a Pt100 or Pt1000 probe connected to the input ⑤ reserved to temperature probes: if this probe is present, the temperature of the combined probes is not used.

In absence of temperature sensors, the lower display shows the MTC (Manual Compensation Temperature) symbol. If the correct value is not entered manually, the extent of the error committed in conductivity measurement is proportional to temperature and  $\alpha_T$  coefficient.

### Choosing the cell constant

The cell constant  $K$  is a piece of information which characterizes the cell. It depends on its geometry and is expressed in  $\text{cm}^{-1}$ . There is no cell capable of measuring the entire conductivity scale accurately enough. Consequently, cells with different constants are used allowing good accuracy on different scales. The cell with constant  $K = 1 \text{ cm}^{-1}$  allows measurements from low conductivity up to relatively high conductivity.

The theoretical measurement cell is made of two  $1 \text{ cm}^2$  metallic plates separated one from the other by  $1 \text{ cm}$ . This type of cell has a cell constant  $K_{\text{cell}}$  of  $1 \text{ cm}^{-1}$ . In essence, the number, form, material and dimensions of the plates in the cell are different from model to model, from manufacturer to manufacturer.

The low constant  $K$  probes are preferably used for low conductivity values, the high constant ones for high values.

The indicative measurement range is reported in the following diagram:

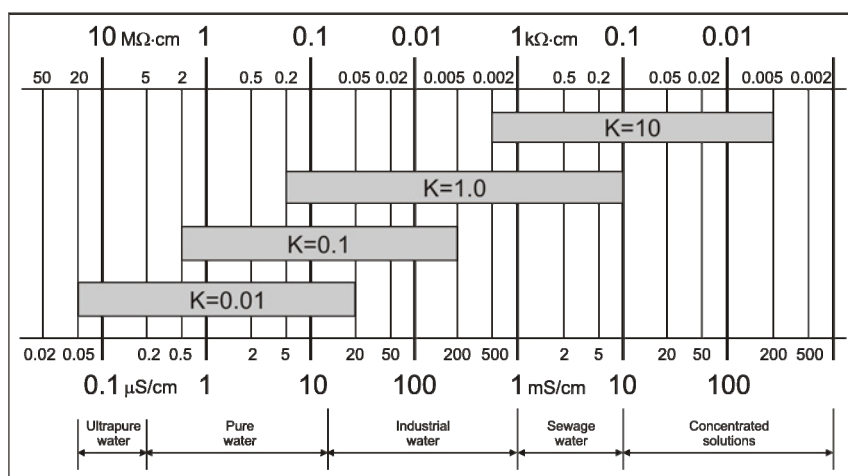

### Automatic or manual temperature compensation for conductivity measurement

The conductivity measurement generally refers to a standard temperature, called **reference temperature**, that is, the instrument proposes the conductivity you would get at the reference temperature. This temperature can be chosen within the range  $0\dots50^\circ\text{C}$  in the “*Conductivity Reference Temperature*” menu item (**usually the values of  $20^\circ\text{C}$  or  $25^\circ\text{C}$  are used**).

The conductivity variation per each grade of temperature variation is a characteristic of the solution and is indicated by the term “**temperature coefficient  $\alpha_T$** ”: admissible values from  $0.00$  to  $4.00\%/^\circ\text{C}$ , **default value  $2.00\%/^\circ\text{C}$** .

When a temperature sensor is present, the instrument automatically applies the temperature compensation function, and proposes the measurement using the reference temperature according to the coefficient  $\alpha_T$  on the display.

In absence of a temperature probe or sensor, the display shows the **MTC** symbol under the measured temperature, to indicate the compensation temperature has been set manually.

The **MTC** (Manual Compensation Temperature) symbol is included in the printouts; if the temperature probe is present, the **ATC** (Automatic Temperature Compensation) symbol is reported. In MTC mode, in order to manually change the compensation temperature press  $F5 = ^\circ\text{C}/^\circ\text{F}$  once: the indicated temperature value starts blinking. Select the desired temperature value by using the  $\blacktriangle$  and  $\blacktriangledown$  arrows, and confirm with ENTER. The display stops blinking, and the temperature displayed is used for compensation.

During manual compensation, to change the unit of measurement between  $^\circ\text{C}$  and  $^\circ\text{F}$ , it is necessary to press the “ $F5 = ^\circ\text{C}/^\circ\text{F}$ ” key **twice**.

## Resistivity, TDS and salinity measurements

The HD22569.2 measures electric conductivity and temperature of a solution, and calculates resistivity, salinity and TDS. By repeatedly pressing “F2 = cond.” you can select the measurement.

The *resistivity* is defined as the reciprocal of conductivity. The measurement is expressed in  $\Omega\cdot\text{cm}$  or one of the derived units ( $\text{k}\Omega\cdot\text{cm}$ ,  $\text{M}\Omega\cdot\text{cm}$  or  $\text{G}\Omega\cdot\text{cm}$ ). It is generally used to measure pure and ultra pure water.

The *salinity* is calculated using a more complex calculation: it is based on the assumption that the measured conductivity is entirely and only due to the sodium chloride (NaCl) dissolved in the water. It is expressed in g/l or mg/l.

The *TDS* (Total Dissolved Solids) is the measurement of the total concentration of ion species in the solution. It is calculated from by multiplying the conductivity measurement by a factor called “*TDS Coefficient*”, set in the menu from 0.4 to 0.8 (MENU >> “Conductivity Measurement Options” >> “*TDS Coefficient*”). The measurement of total dissolved solids is expressed in g/l or mg/l.

## Calibration of conductivity

The probe calibration can be carried out on one to four points, using the standard solutions automatically detected by the instrument (automatic calibration) or other solutions with known temperature characteristics (manual calibration).

### *Technical note on the instrument functioning*

The instrument uses four different automatically selected measurement scales: when the cell constant is equal to 1, the four standard calibration solutions are associated to a different measurement scale. The calibration solution at  $147\mu\text{S}/\text{cm}$  refers to the measurement scale 0, the solution at  $1413\mu\text{S}/\text{cm}$  to the measurement scale 1, and so on. When the calibration point is confirmed using the CAL key (see the details in the next paragraph), the display indicates the calibrated scale (range) with the  symbol.

**If the calibration was performed on multiple solutions, make sure that the  symbol is displayed near a non yet calibrated range: it is useless to calibrate the same range twice.**

This warning is valid only if the cell constant is different from 1, and/or the solutions are not standard.

## Automatic calibration of conductivity using memorized standard solutions

The instrument can recognize four standard calibration solutions:

- 0.001 Molar KCl solution ( $147\mu\text{S}/\text{cm}$  @25°C),
- 0.01 Molar KCl solution ( $1413\mu\text{S}/\text{cm}$  @25°C),
- 0.1 Molar KCl solution ( $12880\mu\text{S}/\text{cm}$  @25°C),
- 1 Molar KCl solution ( $111800\mu\text{S}/\text{cm}$  @25°C),

By using one of these solutions, the calibration is automatic; the calibration can be carried out on multiple points to increase accuracy.

The manual calibration is possible with a different conductivity solution from that used in the automatic calibration.

**The solution temperature for the calibration must be between 15°C and 35°C: if the solution is under 15°C, or over 35°C, the instrument rejects the calibration and displays “NON ACCEPTABLE TEMP”.**

1. Turn the instrument on with the **ON/OFF** key.
2. If the probe is direct, without SICRAM, set the cell constant nominal value in the menu for the probe being calibrated (point 5.3 on page 21).



3. Set the  $\alpha_T$  temperature coefficient in the menu (point 5 on page 20): for Delta OHM calibration solutions, enter 2.00%/°C.
4. Set the reference temperature in the menu (20°C or 25°C) (point 5.1 on page 20):
5. Dip the conductivity meter cell in the calibration solution until the electrodes are covered with liquid.
6. Stir the probe lightly to remove any possible air inside the measurement cell.
7. If the conductivity probe is not fitted with a temperature sensor, connect a temperature probe to the connector ⑤, and immerse it together with the conductivity probe. Alternatively, press °C/°F, set the standard solution temperature value manually by using the ▼ and ▲ arrows (manual setting of temperature). Confirm by pressing ENTER.
8. Press CAL, followed by “F2 = cond.”
9. **The cell constant Kcell is set to the nominal value input in the menu if the probe is direct without SICRAM, or to the value read in the memory of the SICRAM type probe.**
10. Among the standard buffers, the instrument automatically detects the closest to the conductivity value being read, and shows the nominal value at 25°C on the right with a blinking arrow.

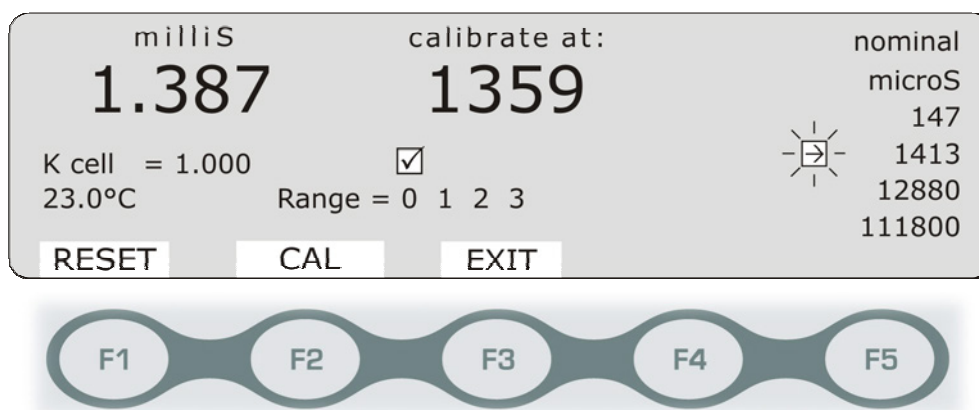

The displays shows on the left the conductivity measurement value based on the cell constant specified before. The recognized standard calibration solution value is displayed in the center. Both values refer to the solution actual temperature, that is, *not compensated*. Also the current cell constant Kcell, the solution temperature and the 4 measurement ranges (Range = 0 1 2 3) are reported.

**If the measurement was TDS, resistivity or salinity, by pressing CAL the instrument goes automatically into conductivity calibration mode.**

11. The detected buffer value, shown in the center, can be modified using the arrows ▲ and ▼.
12. To proceed with the calibration press F2 = CAL. The cell constant actual value is displayed. The ☑ symbol is displayed over the number identifying the calibrated range. The instrument is still in calibration mode: by pressing F2 = CAL again, it is possible to repeat the current calibration point to obtain a finer calibration.
13. To end the calibration and return to measurement, press F3 = EXIT (step 17), or continue the calibration for the next point.
14. Extract the probe from the calibration solution, wash it, clean it carefully, and insert it in the following solution.
15. The instrument proposes the value of the new solution with the blinking arrow. **The previous point is captured permanently.**

16. Continue the calibration by repeating the steps from point 9.
17. To end the calibration press **F3 = EXIT**.
18. Rinse the probe with water. If you are going to perform low conductivity measurements, we recommend rinsing the probe using distilled or bidistilled water.

The instrument is calibrated and ready for use.

**If the probe is not fitted with a SICRAM module, the calibration updates the cell constant and saves it in the instrument's memory. If the probe is fitted with a SICRAM module, the cell constant is saved in the probe's memory.**

**Note: when calibrating multiple points, it is recommended to start from lower values toward higher values, not vice versa.**

### Manual calibration of conductivity using not-memorized standard solutions

Manual calibration is possible at any calibration solution and temperature if it is within the instrument measurement limits and provided that you know the solution's conductivity at the calibration temperature.

**The solution temperature must be between 15°C and 35°C: if the solution is under 15°C, or over 35°C, the instrument rejects the calibration and displays “NON ACEPTABLE TEMP”.**

Proceed as follows:

1. Turn the instrument on with the **ON/OFF** key.
2. If the probe is without SICRAM, set the cell constant nominal value in the menu for the probe (point 5.3 on page 21).
3. Set the  $\alpha_T$  temperature coefficient to 0.0 (point 5 on page 20).
4. Dip the conductivity meter cell into a known conductivity solution. The electrodes must be immersed in the liquid.
5. Stir the probe lightly to remove any possible air inside the measurement cell.
6. Take note of the solution temperature: if the conductivity probe is not fitted with a temperature sensor, connect a temperature probe to the connector ⑤, and immerse it together with the conductivity probe. According to the temperature detected, determine the calibration solution conductivity using the table specifying the conductivity according to temperature.
7. Press **CAL**, followed by “**F2 = cond.**”
8. **The cell constant Kcell is set to the nominal value input in the menu if the probe is without SICRAM, or to the value read in the memory of the probe with SICRAM.**
9. The instrument measures the conductivity value based on the cell constant specified before and displays it on the left column.

If the read value is sufficiently close to the theoretical one, the central column reports the actual value, at the measured temperature, of one of the four standard solutions: an arrow blinks near the detected standard solution, displayed in the list on the right. Continue the calibration from point 9 of the previous chapter “*Automatic calibration of conductivity using memorized standard solutions*”.

The central column reports the same value in the left column, if the calibration solution value is too far from the four standard solutions (147 $\mu$ S/cm, 1413 $\mu$ S/cm,...). Continue the calibration according to the following point.

10. Using the arrows (▲ and ▼) set the conductivity value determined in point 6, and confirm with “**F2 = CAL**”. The cell constant correction is displayed.  
The ☑ symbol is displayed over the number identifying the calibrated range. The instrument is still in calibration mode: by pressing “**F2 = CAL**” again, it is possible to repeat the current calibration point to obtain a finer calibration.
11. To end the calibration and return to measurement, press **F3 = EXIT** (step 17), or continue the calibration for the next point.
12. **If the next calibration solution is one of the standard solutions automatically detected by the instrument**, open the menu and re-enter the temperature coefficient as it was before the calibration. Extract the probe from the calibration solution, wash it, clean it carefully, and insert it in the following solution. Continue the calibration from point 10 of the previous chapter “*Automatic calibration of conductivity using memorized standard solutions*”.
13. **If the next calibration solution is NOT one of the standard solutions automatically detected by the instrument**, extract the probe from the calibration solution, wash it, clean it carefully, and insert it in the following solution.
14. The instrument proposes the value of the new solution: **the previous point is captured permanently**.
15. Continue by repeating the steps from point 8.
16. To end the calibration press “**F3 = EXIT**”.
17. Open again the menu, and re-enter the temperature coefficient as it was before the calibration.
18. Rinse the probe with water. If you are going to perform low conductivity measurements, we recommend rinsing the probe using distilled or bidistilled water.

The instrument is now calibrated and ready for use.

**If the probe is not fitted with a SICRAM module, the calibration updates the cell constant and saves it in the instrument’s memory. If the probe is fitted with a SICRAM module, the cell constant is saved in the probe’s memory.**

#### NOTES:

- **By accessing the calibration, the cell constant Kcell is set to the nominal value input in the menu if the probe is without SICRAM, or to the value read in the memory of the probe with SICRAM.**
- Upon confirming the calibration by using “**F2 = CAL**”, the instrument checks that the correction to the cell constant does not exceed the  $\pm 10\%$  limits. If the calibration is rejected because it exceeds the  $\pm 10\%$  limit, the “**NON ACCEPTABLE %VAR**” message will appear, followed by a long beep. **The instrument remains in calibration mode and maintains the nominal cell constant entered manually in the menu or read from the SICRAM memory:** if you leave the calibration by pressing EXIT, the instrument will preserve the cell constant K nominal value.
- If you get the “**CAL ERROR**” message during calibration, check that the input cell constant is correct.
- The most frequent causes of error are due to the probe malfunctioning due to deposits, dirt or to the standard solutions deterioration (bad preservation conditions, alteration due to pollution with other solutions, ...). Please see the chapter dedicated to troubleshooting on page 47.

**Table of standard solutions at 147 $\mu$ S/cm, 1413 $\mu$ S/cm, 12880 $\mu$ S/cm and 111800 $\mu$ S/cm**

The table reports the standard solutions automatically detected by the instrument according to temperature.

$^{\circ}$ C	$\mu$ S/cm	$\mu$ S/cm	mS/cm	mS/cm
15.0	121	1147	10.48	92.5
16.0	124	1173	10.72	94.4
17.0	126	1199	10.95	96.3
18.0	128	1225	11.19	98.2
19.0	130	1251	11.43	100.1
20.0	133	1278	11.67	102.1
21.0	136	1305	11.91	104.0
22.0	138	1332	12.15	105.9
23.0	141	1359	12.39	107.9
24.0	144	1386	12.64	109.8
25.0	147	1413	12.88	111.8

$^{\circ}$ C	$\mu$ S/cm	$\mu$ S/cm	mS/cm	mS/cm
25.0	147	1413	12.88	111.8
26.0	150	1440	13.13	113.8
27.0	153	1467	13.37	115.7
28.0	157	1494	13.62	117.7
29.0	161	1521	13.87	119.8
30.0	164	1548	14.12	121.9
31.0	168	1581	14.37	124.0
32.0	172	1609	14.62	126.1
33.0	177	1638	14.88	128.3
34.0	181	1667	15.13	130.5
35.0	186	1696	15.39	132.8

## MEASUREMENT OF THE DISSOLVED OXYGEN

HD2259.2 and HD22569.2 measure dissolved Oxygen using combined probes of polarographic, with two or three electrodes, and galvanic type with integrated temperature sensor. The dissolved Oxygen probe is fitted with a “SICRAM” electronic module that stores the last 8 calibrations and the serial number.

The instrument connected to the probe detects the dissolved Oxygen partial pressure in the measured liquid, as well as the temperature and the barometric pressure: using these values, it calculates the dissolved Oxygen concentration (mg/l), and the saturation index (%).

If a temperature only probe is connected (connector ⑤), the measured temperature becomes the reference value for the measurement chain, and has priority on the one supplied by the combined dissolved Oxygen probe.

**The probe is detected during turn on, and this cannot be performed when the instrument is already on, therefore if a probe is connected and the instrument is on, it is necessary to turn it off and on.**

### How to measure

Some instruction on the instrument's operation and measurement mode are reported below.

By pressing the **F2 = O<sub>2</sub>** function key (on the HD2259.2) and **F4 = O<sub>2</sub>** function key (on the HD22569.2), you can select the type of measurement: the **dissolved Oxygen concentration** (mg/l), or the **saturation index** (%).

To measure the dissolved oxygen, immerse in the liquid the polarographic probe to a depth of at least 80 mm or the galvanic probe to a depth of at least 50 mm.

It is essential that the liquid in contact with the membrane is continually changed so as to avoid incorrect measurements caused by Oxygen exhaustion in the liquid sample. Check that the liquid stirring is such that it avoids production of measurement variations.

While immersing the probe, check that no air bubbles remain trapped in contact with the membrane.

When connecting the probe to the instrument and turning it on, wait a few minutes until the reading is stable and reliable. This time span serves to eliminate the dissolved Oxygen in the cell's internal electrolyte. Leave the probe connected to the instrument even if the instrument is in standby to avoid this waiting time; **the mains power supply should be connected.**

The probe connected to the instrument is always powered if the instrument is on or in standby: in this condition the measurement can occur immediately after turning on, once the probe response stabilized.

The instrument enters standby mode only by pressing the ON\_OFF key: if the power supply is removed and then applied again, the instrument does not enter standby mode, but remains completely off: in this case a dissolved oxygen polarographic probe connected to the instrument is not powered until the instrument is turned on with the ON-OFF key.

If the measurements are taken in a container, perform them with the container filled until running over. If possible, fit the container with a stirrer and adjust the stirring speed in order to obtain a stable reading, avoiding trapping air in the liquid.

While measuring running water, for example, water streams, check that the flow speed is sufficient, otherwise remove the probe, pick up a sample and proceed as described above.

## Calibration of the dissolved Oxygen probe

The probe must be calibrated periodically using the DO9709/20 (for polarographic probes DO9709SS, DO9709SM and galvanic probe DO9709SG) or DO9709/21 (for galvanic probe DO9709SS.1) calibrator.

The instrument checks the dissolved Oxygen probe efficiency. The "*OFS\_ERROR*" message indicates that the probe is exhausted.

The same message is displayed during calibration, when calibration is not possible or the reading is unstable. Clean the measurement cell with replacement of the electrolyte and/or the membrane covering the measurement electrodes: if the error indication persists, replace the probe.

Proceed as follows:

1. Connect the probe to the instrument.
2. Disconnect the temperature only probe, if connected to the instrument ☺, so that the indicated temperature is that measured by the dissolved Oxygen probe built-in temperature sensor.
3. Turn the instrument on with the ON/OFF key.
4. Wet the sponge contained in the calibrator using 2 ml of distilled water.
5. Insert the probe into the calibrator.
6. Wait a few minutes until the system stabilizes thermally and saturation is reached inside the calibrator.
7. Press **CAL**, then "**F4 = oxy**" (by accessing the calibration, the slope is set to 1.000 and the previous calibration information are transferred in the "**Dissolved Oxygen Probe Calibration History**"). The saturation index value is displayed in the center. The temperature, barometric pressure and slope values on the right.

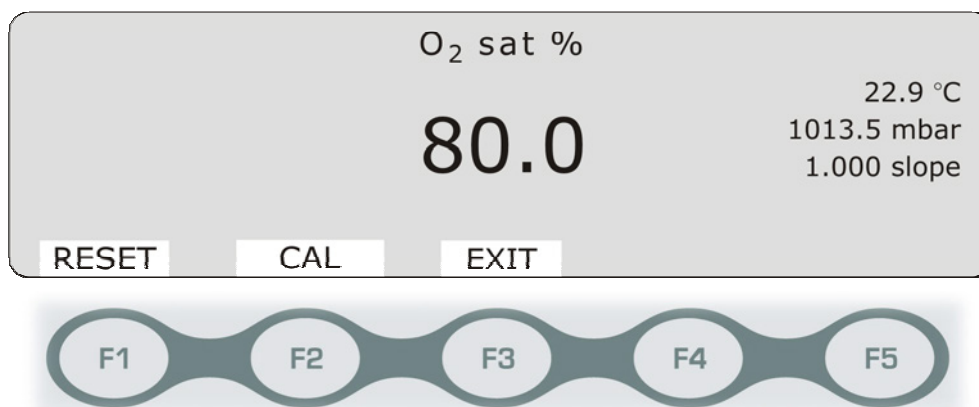

8. To proceed with the calibration press **F2 = CAL**. The calibration value 101.7% is displayed, and on the right the new slope value, corrected according to the new calibration.
9. If the measurement did not stabilize, press **F2 = CAL** again to repeat the calibration.
10. To end the calibration and return to measurement, press **F3 = EXIT**.

**The instrument is calibrated and ready for use.**

If an error is made during calibration, you can press **F1 = RESET** to reset the slope value to 1.000. You must repeat the calibration.

On pressing **F2 = CAL** during calibration, the instrument checks that the correction to be made does not exceed the expected limits for correct functioning. If the calibration is rejected, the display shows "**SLOPE ERROR**", the calibration is ended and the slope value is set to 1.000.

In case of "**SLOPE ERROR**", replace the electrolyte and the membrane. If the error persists after an accurate cleaning, replace the probe.

### Electrolyte solution and/or membrane replacement

The probe is supplied already filled with electrolyte solution and is ready for use. The electrolyte contained in the dissolved oxygen probe will be exhausted because of the chemical reaction generated by the current in proportion to the partial pressure of the oxygen present in the water. Subsequently, the current generated by the probe is so low that the calibration operation is impossible. It is necessary to replace the electrolyte contained in the probe to restore its functionality.

Incorrect use of the probe can cause the rupture or obstruction of the oxygen-permeable membrane containing the electrolyte solution. In this case it is necessary to replace the membrane and the electrolyte solution.

After replacement of the electrolyte solution and/or membrane, insert the probe's connector in the instrument and wait 2 hours before performing the dissolved oxygen measurement (this is the necessary time to exhaust the oxygen trapped in the electrolyte solution during the replacement).

### DO9709SM POLAROGRAPHIC PROBE

1. Remove the protective container from the head of the probe.
2. Unscrew the probe's head with the membrane permeable to oxygen.
3. If necessary, replace the membrane.
4. Fill the head of the probe with the supplied electrolyte solution.
5. Eliminate any possible air bubble in the electrolyte solution.
6. Screw the probe's head back on carefully.

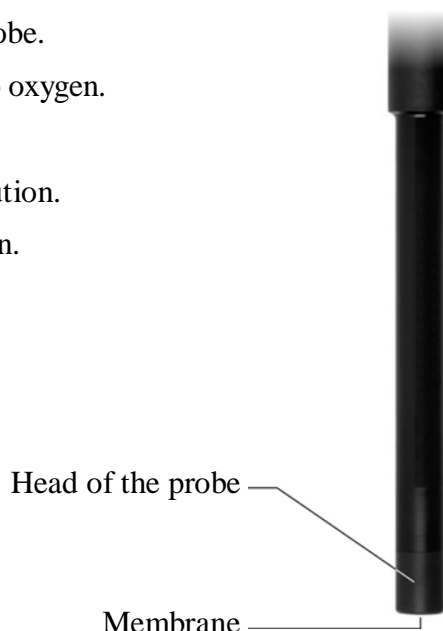

### DO9709SG GALVANIC PROBE

1. Remove the protective container from the head of the probe.
2. Unscrew the cap of the filling hole and the head of the probe with the membrane permeable to oxygen (check that the membrane is in good condition).

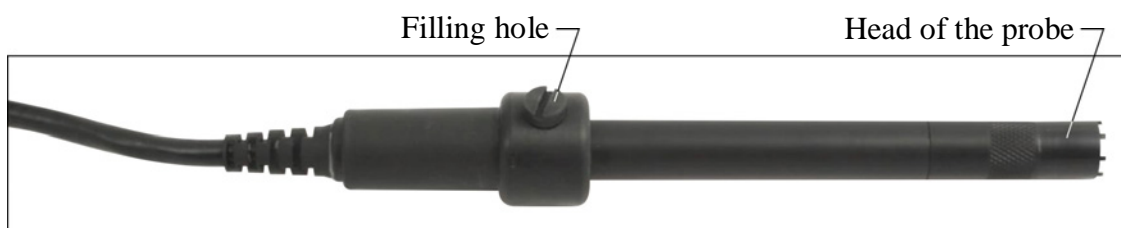

3. Fill the head of the probe up to  $\frac{3}{4}$  with KOH electrolyte solution.
4. Screw the head of the probe with the electrolyte solution to the probe. Rinse any excess electrolyte solution with water.

5. Pour the electrolyte solution in the filling hole (the probe filling requires about 5 ml of solution). From time to time, gently tap the probe stem to remove any air bubbles.

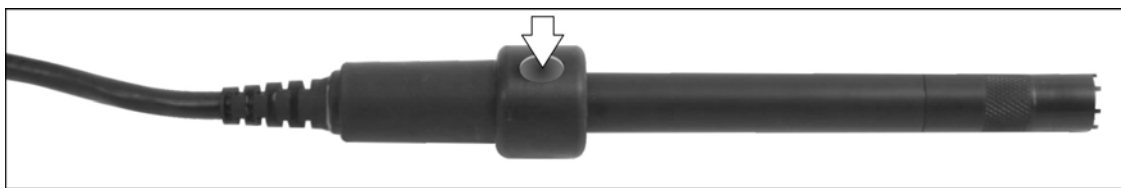

6. When the filling hole is full, screw the cap back on. Rinse any excess electrolyte solution with water.
7. Place the probe with the membrane upwards and check that there are no air bubbles under the membrane. If you notice air bubbles, further fill the probe with electrolyte solution.
8. Wait approximately 2 hours before using the probe, then calibrate.



**ATTENTION:**

**The electrolyte solution contains Potassium Hydroxide (KOH) and is caustic! Avoid contact with skin, use suitable gloves and protect the eyes. In case of contact, rinse immediately and thoroughly with water.**

*Note:* some residues (lead oxide and carbonate) due to the reaction of the electrolyte solution with oxygen can be visible inside the membrane; such residues do not compromise the probe operability and can be removed by unscrewing the head of the probe and rinsing the membrane during the regular periodic maintenance. The accumulation of many residues in a short time (few days) may indicate the presence of air bubbles inside the probe due to an incorrect filling, to the cap not sufficiently closed or to leakage in the membrane.

**DO9709SS POLAROGRAPHIC PROBE**

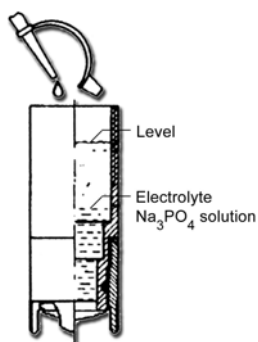

1. Unscrew the probe's head with the membrane permeable to oxygen.
2. If necessary, replace the membrane.
3. Fill the probe's head with the DO 9701 electrolyte solution until the level indicated in the figure (filling level).
4. Eliminate any possible air bubble in the electrolyte solution.
5. Screw the probe's head back on carefully.

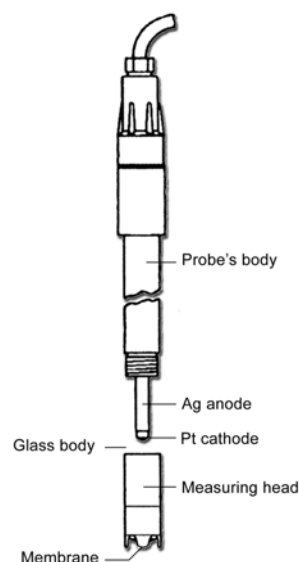



## DO9709SS.1 GALVANIC PROBE

1. Unscrew the probe's head and the membrane permeable to oxygen. If necessary, replace the membrane.



2. Attach the needle to a 10 ml syringe.
3. Using the syringe, withdraw the DO 9701.1 electrolyte solution.
4. Remove the air bubbles inside the syringe. Insert the needle into one of the four holes surrounding the cathode of the probe and inject the solution until it leaks out. The fill volume is approximately 5 ml.

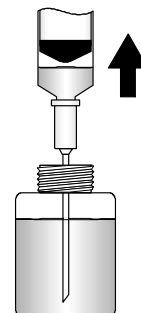
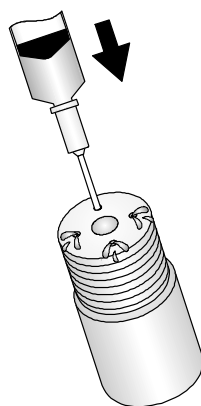

5. Screw the probe's head back on carefully.

### Check the probe's status

The glass body covering the cathode of the polarographic probe and the membrane on the probe's head should not be damaged.

If there are cracks in the glass body, the probe must be replaced. If the oxygen-permeable membrane is damaged, dirty or obstructed it must be replaced. When the probe's head is unscrewed the probe is not protected. Handle it with care to avoid collisions that could damage it irreparably.

### Control the zero of the probe

Compensation of the zero (offset) of the probe is already done in the factory.

The user can control the offset by immersing the probe in the 0.0% dissolved Oxygen solution (DO 9700):

- pour a small quantity of 0.0% dissolved oxygen solution into a container, after suitably cleaning the container with distilled water,
- insert the probe in the zero solution and wait at least 5 minutes,
- the instrument should indicate a saturation index  $< 0.6\%$ .

### Dissolved Oxygen probe storage

When the dissolved oxygen probe is not used it should be disconnected from the instrument to avoid useless consumption of the electrolyte solution and the discharge of the batteries.

When no measurement is taken for long periods, withdraw the internal electrolyte of the galvanic probe, to avoid useless consumption of the measurement electrodes.

Always keep the electrode wet using the special cap provided with the probe and filled with distilled water.

### **Polarographic probe and galvanic probe: differences**

To help choosing between the use of a polarographic or galvanic probe, the following table summarizes the main differences between the two probes.

	<b>Polarographic probe DO9709SM</b>	<b>Galvanic probe DO9709SG</b>
<i>Polarization time</i>	After connecting the probe to the instrument it is necessary to wait at least 5 minutes before taking the measurement.	Polarization is not needed. After connecting the probe to the instrument it is possible to take the measurement immediately.
<i>Flow rate</i>	Requires a lower flow rate (> 9 cm/s), because it consumes less oxygen.	Requires a higher flow rate (> 20 cm/s), because it consumes more oxygen.
<i>Electrodes life</i>	Longer, because the electrodes are not consumed when the probe is disconnected from the instrument.	Shorter, because the electrodes are consumed even when the probe is disconnected from the instrument (if the electrolyte is not removed).
<i>Maintenance</i>	Requires little maintenance.	The electrolyte solution must be replaced more frequently.
<i>Accuracy</i>	Higher accuracy ( $\pm 1\%$ f.s.).	Standard accuracy ( $\pm 2\%$ f.s.).

### **Firmware update for DO9709SM and DO9709SG probes**

The DO9709SM and DO9709SG probes are compatible with the instruments HD2259.2 and HD22569.2 starting from firmware version **1.05.017**. The instruments with previous firmware versions must be updated.

## TEMPERATURE MEASUREMENT

The instrument accepts Platinum temperature probes with resistances of 100Ω or 1000Ω at 0°C, with SICRAM module or direct sensor, in the input ⑤ reserved to temperature probes. The Pt100 are connected to 4 wires, the Pt1000 to 2 wires. The instrument, according to the version, can also measure the temperature using the combined pH/temperature, conductivity/temperature and dissolved Oxygen/temperature probes.

The temperature sensor excitation current was chosen in order to minimize the sensor self-heating effects.

All probes with SICRAM module are calibrated in the factory. The 4 wire and 2 wire probes with direct input **are checked for conformity with class A tolerance** according to norm IEC751 - BS1904 - DIN43760.

**The probes are detected during turn on: if a probe is connected and the instrument is on, it is necessary to turn it off and on.**

The °C or °F unit of measurement can be chosen for display, printing, and logging using the **F5 = °C/°F** key.

The displayed temperature is used for pH, conductivity (according to the models ) or dissolved Oxygen compensation. If no temperature or combined temperature probes are present, the manual temperature is displayed: the **MTC** message is displayed. If at least one temperature probe is connected (temperature only probe or combined probe), the message become **ATC**. The measured temperature is used to compensate the pH, conductivity and dissolved Oxygen measurements.

In case of multiple temperature sensors connected to the instrument (e.g. Pt100 probe, pH/temperature probe with SICRAM, combined conductivity or dissolved Oxygen probe), the **reference** temperature to compensate **all** measurements, is chosen according to the following principle: **the temperature only probe ⑤ has priority on the temperature supplied by combined probes. If the temperature only probe ⑤ is not present, priority is given according to the connector sequence from left to right:** e.g. the first pH SICRAM input ③ has priority on the dissolved Oxygen ⑥, on the conductivity SICRAM input ⑦, and on the conductivity direct input ⑧.

If you disconnect the reference temperature probe (temperature only probe or combined probe), the instrument switches from ATC to MTC mode, unless other probes are connected. The temperature used for compensation is the one manually set using the “F5 = °C/°F” function (see the description on page 13).

### How to measure

The temperature measurement by **immersion** is carried out by inserting the probe in the liquid for at least 60mm; the sensor is housed in the end part of the probe.

In the temperature measurement by **penetration** the probe tip must be inserted to a depth of at least 60mm, the sensor is housed in the end part of the probe. When measuring the temperature on frozen blocks it is convenient to use a tool to bore a cavity in which to insert the tip probe.

In order to perform a correct **contact** measurement, the measurement surface must be even and smooth, and the probe must be perpendicular to the measurement plane.

**So as to obtain the correct measurement, the insertion of a drop of oil or heat-conductive paste is useful (do not use water or solvents). This method also improves the response time.**

**Instructions to connect the TP47 connector for Pt100 probes or Pt1000**

All Delta Ohm probes are provided with a connector. The HD2259.2 and HD22569.2 instrument also work with direct 4 wire Pt100, and 2 wire Pt1000 probes manufactured by other producers: for the instrument connection is prescribed the TP47 connector to which the probe's wires should be welded.

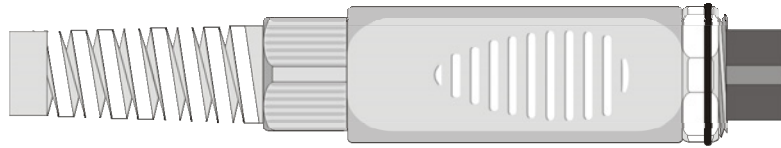

The instructions to connect the Platinum probe to the TP47 module are provided below. The module is supplied complete with fairlead and gasket for 5mm maximum diameter cables. Do the following to open the module and connect a probe:

Unscrew the fairlead and extract the gasket, remove the label using a cutter, unscrew the ring on the opposite side as illustrated in the figure:

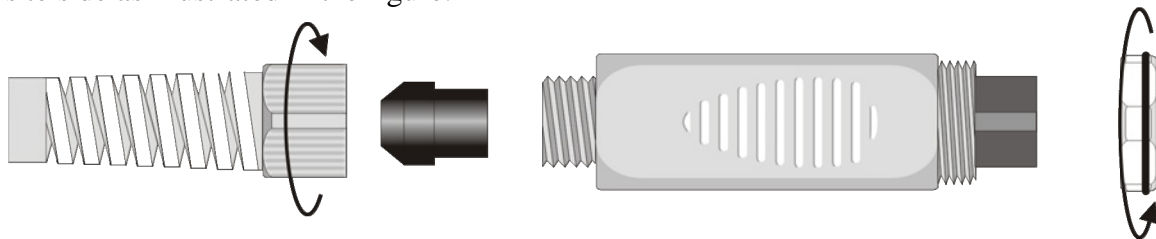

Open the two module shells: the printed circuit to which the probe must be connected is housed inside. On the left there are the 1...4 points on which the sensor wires must be welded. The JP1...JP4 jumpers are in the center of the card. These must be closed with a tin bead for some type of sensors:

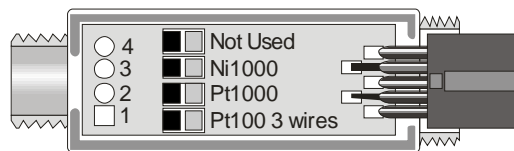

Before welding, pass the probe cable through the fairlead and gasket. Weld the wires as shown in the table:

Sensor	Card connection	Jumper to close
Pt100 4 wires		None
Pt1000 2 wires		JP2

Ensure the welds are clean and perfect. Once the welding operation is complete, close the two shells, insert the gasket in the module, and screw the fairlead. At the other end of the module, enter the ring with the O-Ring as indicated in the picture.

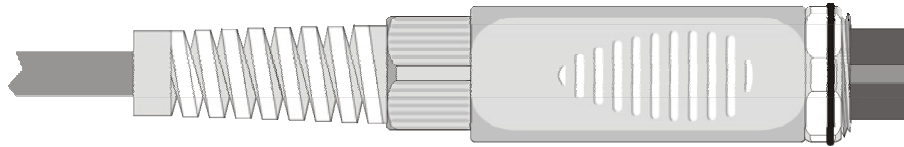

Make sure the cable is not twisted while you are screwing the fairlead. Now the probe is ready.

**Direct connection of the 4 wire Pt100 sensor to a DIN45326 connector**

Sensor	Direct connection to the connector
<b>4 wire Pt100</b>	<p>View of female connector, solder side</p>

The **4-wire Pt100** sensor can be welded directly on the DIN45326 female connector's pins, without using the TP47 card. The 4 wires of the Pt100 are welded as outlined in the scheme on the side.

The Pt100 probe is detected during turn on: insert the probe when the instrument is off, and switch it on.

This connection does not guarantee the IP66 protection degree.

## WARNINGS AND OPERATING INSTRUCTIONS ON THE TEMPERATURE SENSORS

1. Do not expose the probes to gases or liquids that could corrode the material of the sensor or the probe itself. Clean the probe carefully after each measurement.
2. Do not bend the probe connectors or force them upward or downward.
3. If the connector is fitted with a seal rubber ring (O-ring), make sure it is inserted all the way.
4. Do not bend, deform or drop the probes, as this could cause irreparable damage.
5. Always select the most suitable probe for your application.
6. Do not use the temperature probes in presence of corrosive gases or liquids. The sensor container is made of AISI 316 stainless steel, while the contact probe container is made from AISI 316 stainless steel plus silver. Avoid contact between the probe surface and any sticky surface or substance that could corrode or damage it.
7. Avoid blows or thermal shocks to Platinum temperature probes as this could cause irreparable damage.
8. To obtain reliable measurements, temperature variations that are too rapid must be avoided.
9. Temperature probes for surface measurements (contact probes) must be held perpendicular against the surface. Apply oil or heat-conductive paste between the surface and the probe in order to improve contact and reduce reading time. Whatever you do, do not use water or solvent for this purpose. A contact measurement is always very hard to perform. It has high levels of uncertainty and depends on the ability of the operator.
10. Temperature measurements on non-metal surfaces usually require a great deal of time due to the low heat conductivity of non-metal materials.
11. Probes are not insulated from their external casing; be very careful not to come into contact with live parts (above 48V). This could be extremely dangerous for the instrument as well as for the operator, who could be electrocuted.  

12. Avoid taking measurements in presence of high frequency sources, microwave ovens or large magnetic fields; results may not be very reliable.
13. Clean the probe carefully after use.
14. The instrument is water resistant and IP66, but should not be immersed in water. Close the free connectors using caps. The probe connectors must be fitted with sealing gaskets.

## INSTRUMENT STORAGE

Instrument storage conditions:

- Temperature: -25...+65°C.
- Humidity: less than 90% RH without condensation.
- During storage avoid locations where:
  - humidity is high,
  - the instrument may be exposed to direct sunlight,
  - the instrument may be exposed to a source of high temperature;
  - the instrument may be exposed to strong vibrations;
  - the instrument may be exposed to steam, salt or any corrosive gas.

The instrument case is made of ABS plastic and rubber: do not use any incompatible solvent for cleaning.

## **pH, CONDUCTIVITY AND DISSOLVED OXYGEN MEASUREMENTS - MOST FREQUENT PROBLEMS, POSSIBLE CAUSES AND HANDLING**

### **Instrument functioning**

- *When selecting some functions the “Operation reserved to the administrator” message is displayed on the screen.*

Some functions are reserved to the user registered as "Administrator". The other users cannot execute them (see the details on page 22).

- *Clicking on the LOG key the “Logging is disabled!” message is displayed on the screen.*

The logging interval was set to 0. To enable it, open the menu “*System Parameters >> Memory and Logging Options >> Select log interval*”, and select a log interval different from zero.

### **pH measurement**

The average life of a pH electrode is about one year according to the use and maintenance performed.

The electrodes used at high temperatures or in highly alkaline environments have a shorter life.

It is recommended to condition the new electrodes for half day by immersing them, before use, into a buffer at 6.86pH or 4pH.

Calibrate the electrode with solutions closer to the values being measured. A new electrode must always be calibrated at neutral pH (6.86pH) first point, and at least a second point.

Generally, the pH electrodes have a body in glass: handle them with care to avoid breakage. In particular, the membrane (the sensitive element housed in the end part of the electrode) is made of very thin glass.

Some of the most frequent problems and their possible solutions are reported below.

#### **Wrong pH measurement.**

Carry out the following checks:

- Check that the diaphragm is not obstructed and possibly clean it using the HD62PT solution.
- Check that the reference system is not contaminated. In case of a filling type electrode, replace the electrolyte with the suitable solution.
- Check that no air bubbles are present in the electrode tip and that it is sufficiently immersed.

Dirt residuals deposited on the membrane can alter the measurement: use the **HD62PP** solution for protein cleaning.

**Slow response or wrong measurements.** Possible causes are aging or erosion of the membrane or a connector short circuiting.

**Storage. Keep the electrode immersed in the HD62SC solution.**

## **Conductivity measurement**

The service life of a cell can be unlimited, provided that the necessary maintenance is performed and that it does not break. Some of the most frequent problems and their possible solutions are reported below.

### **Measurement of conductivity different from the expected value.**

**Check that the probe is connected to the correct input: input ⑦, for a SICRAM type probe, input ⑧ for a direct type probe without SICRAM.** Check that the cell used is suitable for the measurement range. Check that the cell is not dirty, that there are no air bubbles inside it. Repeat the calibration using the proper not contaminated standard.

### **Slow response or instability.**

Check that the cell is not dirty, that there are no traces of oil or air bubbles inside it. If you work with a Platinum cell, new platinum-coating of the electrode could be necessary.

### **Cell constant K value not accepted.**

Check that the standard solutions are in good condition, that the probe's constant cell value coincides with that selected in the instrument menu, and that the calibration solution temperature is within the range 15...35°C.

## **Measurement of the dissolved Oxygen**

The body of the DO9709SS probe is in POM. The body of the DO9709SS.1 probe is in Epoxy. The body of the DO9709SM and DO9709SG probes is in ABS. The membrane is in PTFE.

During use, control the compatibility of these materials with the liquid that you want to measure.

The probe must be kept wet by using its protection.

Regularly check that no obstructions are present on the membrane.

Do not let hands touch the membrane.

During measurement, make sure the membrane is not coming into contact with objects that could tear it off.



## INSTRUMENT SIGNALS AND FAULTS

The following table lists all error indications and information displayed by the instrument and supplied to the user in different operating situations:

Display indication	Explanation
<b>ERROR</b>	Appears if the pH measurement exceeds the -2.000pH...19.999pH limits, if the mV measurement exceeds the $\pm 2.4V$ limits.
<b>OVER</b>	Measurement overflow: this appears when the probe measures a value exceeding the measurement range or the mV measurement is included in the +2.0...+2.4V range.
<b>UNDR</b>	Measurement overflow: this appears when the mV measurement is included in the -2.4...-2.0V range.
<b>LOG MEM FULL</b>	Memory full; the instrument cannot store further data, the memory space is full.
<b>PROBE ERROR</b>	A probe with SICRAM module has been inserted when not admissible for that specific instrument.
<b>SYS ERR #</b>	Instrument management program error. Contact the instrument's supplier and communicate the numeric code # reported by the display.
<b>CAL LOST</b>	Program error: it appears after turning on for a few seconds. Contact the instrument's supplier.
<b>CAL blinking</b>	Calibration not completed correctly.
<b>OFS ERROR</b>	The dissolved Oxygen probe is exhausted. See the paragraph " <i>Calibration of the dissolved Oxygen probe</i> "
<b>STANDBY</b>	The message scrolls on the display. It is the normal working mode of the instrument when connected to the mains and the ON-OFF key is pressed to turn it off.

## SERIAL INTERFACE AND USB

All instruments are fitted with an electrically isolated RS-232C serial interface, and an USB 2.0 interface. Optionally, they can be connected using a serial cable with sub D 9-pole female connectors (code **9CPRS232**) and a cable with USB 2.0 connectors (code **CP22**).

The USB connection requires the previous installation of a driver included in the DeltaLog11 software package. **Install the driver before connecting the USB cable to the PC** (follow the instructions included in the software package).

Standard parameters of the instrument serial transmission are:

- Baud rate    38400 baud
- Parity        None
- N. bit        8
- Stop bit     1
- Protocol     Xon/Xoff

It is possible to change the RS232C serial port baud rate by setting the "*Selection of the serial transmission speed (Baud Rate)*" parameter in the menu (please see page 19). The possible values are: 115200, 38400, 19200, 9600, 4800, 2400, 1200. The other transmission parameters are fixed. The USB 2.0 connection does not require the setting of parameters (Baud rate = 460800 fixed).

**The selection of the port is carried out directly by the instrument: if the USB port is connected to a PC, the RS232 serial port is automatically disabled.**

All the commands transferred to the instrument must have the following structure:

**XXCR** where: **XX** is the command code and **CR** is the Carriage Return (ASCII 0D)

The XX command characters are exclusively upper case characters. Once a correct command is entered, the instrument responds with "&"; when any wrong combination of characters is entered, the instrument responds with "?".

The instrument response strings end with the sending of the CR (Carriage Return) and LF (Line Feed) command, preceded by the "[" character, that is, the combination "[CRLF".

Before sending commands to the instrument via the serial port, locking the keyboard to avoid functioning conflicts is recommended: use the P0 command. When complete, restore the keyboard with the P1 command.

COMMAND	ACTION	RESPONSE	NOTES
AA	Model request	HD2259-2 pH/Oxy/temperature	HD2259.2 = pH + Oxy HD22569.2 = pH+conduct.+Oxy
AG	Firmware version	Firmware 1.00.100	
AH	Firmware date	2006_01_31	
AS	Serial number	Ser. Number=00000000	
AU	User identification	User=FACTORY User=Administrator User=User_1 User=User_2 User=User_3 User=Anonymous	

<b>COMMAND</b>	<b>ACTION</b>	<b>RESPONSE</b>	<b>NOTES</b>
<b>AZ</b>	Full heading	HD2259-2 Firmware 1.00.100 2006_01_31 Ser. number=00000000 Calibrated 01-FEB-06 00:01:00 User=Administrator Communication interface=USB Temp.comp. mode=AUTOMATIC Temp. sensor = Pt100	
<b>DA</b>	Input date-time	&/?	From 2005/12/12 12:34:56 It rejects any incorrect date
<b>FA</b>	Clock date request	060414092400	Current date “yy/mm/dd hh/mm/ss”, HEX format
<b>FB</b>	Clock date request	06-12-31 00:33:27	Current date “yy-mm-dd hh:mm:ss”
<b>FD</b>	Instrument calibration request	060414092400	Calibration date “yy/mm/dd hh/mm/ss”, HEX format
<b>FE</b>	Instrument calibration request	06-12-31 00:00:00	Current date “yy-mm-dd hh:mm:ss”
<b>K1</b>	Print current measurements	Same as manual print	It increases the ID
<b>K2</b>	pH calibration status	Same as manual print	
<b>K4</b>	pH calibration history	Same as manual print	
<b>K6</b>	Last conductivity calibration	Same as manual print	Only HD22569.2
<b>K7</b>	O <sub>2</sub> calibration history	Same as manual print	
<b>KE</b>	Exit from memory mode	&	
<b>KL</b>	Activate log	&	
<b>KM</b>	Activate memory display mode	&	Not accepted if no data present in the memory
<b>KQ</b>	Stop log + save operating parameters	&	Use it also to only save the operating parameters
<b>KS</b>	Single line continuous printing	&	
<b>KT</b>	Stop single line printing	&	
<b>LDxxxx</b>	Memory dump no. xxxx+1	Dump or ?	
<b>LN</b>	N° of next memory location request	Next avail. memory=0001	
<b>LR</b>	Setting of the displayed memory index	&/?	lr3 ---> shows memory no. 4
<b>P0</b>	Ping & lock keys	&	
<b>P1</b>	Ping & unlock keys	&	
<b>RA</b>	Read log interval	Print Interval= 000	
<b>RE</b>	Read current endpoint status	Endpoint mode = 0	
<b>RF</b>	Read parameter $\alpha_T$	Chi alfa = 2.00	Only HD22569.2
<b>RH</b>	Read pH electrode calibration expiration	pH cal exp.days = 0	
<b>RI</b>	Read parameter ID	Sample ID= 00000001	
<b>RK</b>	Read cell constant Kcell	Chi nominal Kcell = 0.700	Only HD22569.2

<b>COMMAND</b>	<b>ACTION</b>	<b>RESPONSE</b>	<b>NOTES</b>
<b>RL</b>	Read parameter "Print and Storage Mode"	Print&mem = 0	0 = only print, 1 = print and record
<b>RM</b>	Read parameter "Storage Mode"	Memory mode = 0	0 = standard 1 = cyclic
<b>RO</b>	Read parameter "O <sub>2</sub> probe calibration expiration"	Oxy cal exp.days = 0	
<b>RP</b>	Read pH resolution	pH resolution = 1/1000	pH resolution: 1/100
<b>RQ</b>	Read salinity	Salinity = 11.1	g/l
<b>RR</b>	Read conductivity reference temperature	Chi ref temp= 25.00	Only HD22569.2
<b>RS</b>	Read conductivity TDS factor	Chi TDS factor= 0.500	Only HD22569.2
<b>RT</b>	Read temperature mode	Temp_MODE = 0	0 = MTC - 1 = ATC
<b>RU</b>	Read set units of measurement.	&0;0;1;0;	0 = pH, 1= mV 0 = micros, 1 = ohm, 2 = TDS, 3 = NaCl 0 = °C, 1 = °F 0 = sat% 1 = mg/l
<b>SH</b>	Read pH calibration status	pH calibration status = valid pH calibration status = expired!	
<b>SO</b>	Read O <sub>2</sub> calibration status	oxy calibration status = valid oxy calibration status = expired!	
<b>Uxy</b>	Setting of the displayed unit of measurement	x = 0...3 // pH, cond, temp, oxy y = see the RU codes	
<b>WA</b>	Setting log interval	&/?	0...999
<b>WE</b>	Setting Endpoint mode	&/?	0 = endpoint "dir" 1 = endpoint "man" 2 = endpoint "time" 3 = endpoint "auto"
<b>WF</b>	Setting temperature coefficient $\alpha_T$	&/?	0...400 = 0.00 ... 4.00 % Only HD22569.2
<b>WH</b>	Setting pH calibration validity number of days.	&/?	0 ... 999
<b>WI</b>	Setting sample identification number	&/?	00000000 ... 99999999
<b>WL</b>	Setting print and storage mode	&/?	0 = only print, 1 = print and record
<b>WM</b>	Setting storage mode	&/?	0 = linear logging mode 1= cyclic logging mode
<b>WO</b>	Setting O <sub>2</sub> calibration validity number of days.	&/?	0 ... 999
<b>WP</b>	Setting pH Resolution	&/?	0 = 2 decimal positions 1 = 3 decimal positions
<b>WQ</b>	Setting salinity for O <sub>2</sub> measurement	&/?	0..700 = 0.0 70.0 g/l
<b>WR</b>	Setting conductivity reference temperature	&/?	0 ... 5000 = 0.00 50.00 °C Only HD22569.2
<b>WS</b>	Setting conductivity TDS factor	&/?	400 ... 800 = 0.400 ... 0.800 Only HD22569.2
<b>WT</b>	Setting MTC temperature	&/?	-500 ... +1500 = -50 ... +150 °C

## STORING AND TRANSFERRING DATA TO A PC

The HD2259.2 and HD22569.2 instruments can be connected to a personal computer via an RS232C serial port or an USB port, and exchange data and information through the DeltaLog11 software running in a Windows operating environment (see the details on the previous chapter). Both models can print (PRINT key) the measured values on a 24 column printer (HD40.1) and store them in the internal memory using the logging function (MEM key). The stored data can be recalled to be viewed directly on the instrument display, printed or transferred to the PC.

### THE RECORD FUNCTION

The instrument allows the recording of up to 2000 screens in its internal memory. Each screen is made of the measurements detected by the probes connected to the inputs. The stored parameters are those shown on the display and selected using the **F1**, **F2** keys for the HD2259.2 and the **F1**, **F2**, **F3** keys for the HD22569.2.

Two recording modes are available: one upon command and the other continuous.

- The *on command* mode memorizes the current screen by pressing **MEM** or “**SHIFT/FNC**” >> “**F1 = M-STOR**”.
- The *continuous* mode memorizes the screens according to an interval that can be set in the menu.

The logging starts by pressing the **LOG** key and ends by pressing the same key again: the data memorized form a continuous block of data.

The logging interval can be set from 1 to 999 seconds. To enable it, open the menu “*System Parameters >> Memory and Logging Options >> Select log interval*” (see the description of the menu items on page 18).

The data stored in the memory can be transferred to a PC using the DeltaLog11 software: please see the software help for the details.

To display the recorded data directly on the instrument display, press the “**SHIFT/FNC**” and then the “**F5 = M-VIEW**” key.

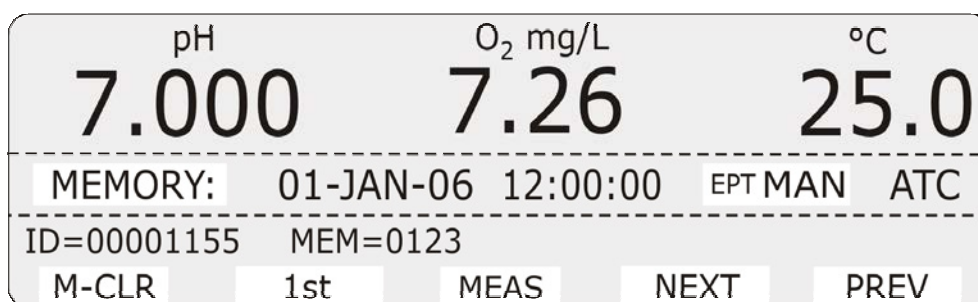

To browse the recorded data use the function keys:

“**F2 = 1st**” to display the first data on memory

“**F4 = NEXT**” to see the next sample

“**F5 = PREV**” to see the previous sample

To print the current screen, press the **PRINT** key.

To return to measurement, press “**F3 = MEAS**”.

## CLEARING THE MEMORY

To clear the memory, start the stored data display mode by pressing “SHIFT/FNC” >> “F5 = M-VIEW”. Press the “F1 = M-CLR” function key.

The window to confirm the operation will appear: “CLEAR MEMORY???”. Press the “F1 = NO” function key to cancel the operation, or the “F5 = YES” function key to confirm.

The instrument starts clearing the internal memory; at the end of the operation, it goes back to normal display.

### NOTES:

- The data transfer carried out using the DeltaLog11 software does not cause the memory to be erased; the operation can be repeated as many times as required.
- The recorded data remain in the memory even if the instrument is turned off or disconnected from the mains, if the recording was complete.
- **Memory clearing can be performed only by the administrator** (see page 22).

## THE PRINT FUNCTION

Press PRINT to send the measured data directly to the RS232 and USB ports, in real time. Print data units of measurements are the same as those used on the display, as selected using the F1, F2 and F3 function keys.

A printer with serial input can be connected to the RS232C port (e.g. the Delta Ohm 24 column printer code HD40.1).

The RS232C and USB ports can be connected to the corresponding ports on the PC using the appropriate cables: 9CPRS232 for the RS232C serial, CP22 for the USB.

The instruments detect automatically the presence of a connection to the USB port: in this case the RS232C serial port is disabled.

### NOTES:

- The print out is formatted across 24 columns.
- In order to print the data to a parallel interface printer, you must use a parallel-serial adaptor (not supplied).
- **The direct connection between instrument and printer via a USB connector does not work.**

*Example of a printout obtained using the printer*

*NOTES*

```
HD2259.2
pH / oxygen / temperature
2006 - 01 - 31 12:00:00
LAB POSITION #1

Operator = Administrator

SAMPLE ID = 00000001

pH EL sernum = 01234567
pH = 7.010
pH out of calibration !

O2 EL sernum = 76543210
mg/l O2 = 5.59

Temp = 25.0°C ATC
```

Instrument model

Current date and time in the format  
year-month-day hours:minutes:seconds

Instrument name

Operator (Administrator or User\_1, User\_2,  
User\_3 or Anonymous)

Number of the sample

Serial number of the pH electrode

pH measurement

The calibration validity period has expired  
(otherwise the calibration date is shown)

Serial number of the dissolved Oxygen probe

Measurement of the concentration of dissolved  
Oxygen

Temperature measurement

ATC = automatic compensation

MTC = manual compensation

## BACKUP BATTERY REPLACEMENT

The instruments are fitted with a backup battery that maintains the configuration data in the memory and ensures the functioning of the clock without power supply.

The battery operates only when the instrument is not powered by the mains. The low power consumption ensures a long life of the battery.

The battery charge status is constantly monitored: when the battery is low, the BACKUP BATTERY LOW!!! message is displayed: the battery must be replaced as soon as possible.

The 3.6V type ½AA Lithium battery (diameter x length = 14mm x 25mm) with axial rheophores: in the following picture is shown a battery in its correct position, the positive pole is directed downwards.

**Before replacing the discharged battery, complete the logging operations in progress, and turn the instrument off. Remove the power supply cable.**

**To avoid losing the configuration data, the battery change should not take over one minute, otherwise the instrument has to be reconfigured.**



### Procedure

1. Unscrew the 6 screws on the back.
2. Lift the front making sure the flat cables that connect the various instrument parts are not disconnected.
3. Cut the rheophores of the new battery to a length of about 15 mm.



4. Cut the strip blocking the discharged battery to the printed circuit.
5. Remove the discharged battery.
6. Put the new battery in **making sure the polarity is correct: the negative pole is directed toward the back.**
7. Fix the battery with a new strip.
8. Close the instrument back using the 6 screws.



### Authorized use

The instrument has been designed exclusively for laboratory measurements.

Comply with the technical specifications outlined in the chapter “TECHNICAL CHARACTERISTICS”. Its use is authorized only in conformity with the instructions written in this manual. Any different use is considered improper.

### General instructions on security

This instrument has been manufactured and tested according to safety regulation EN 61010-1:2010 concerning electronic measurement instruments and was delivered ex factory in perfect security conditions.

Its regular functioning and operating security can be ensured only if all the normal safety measures as well as the specifications described in this manual are complied with.

Its regular functioning and operating security is ensured only within the climatic conditions specified in the chapter “TECHNICAL CHARACTERISTICS”.

If the instrument is moved from a cold to a hot environment, or vice versa, the condensation can disturb its functioning. You need to wait for the instrument to reach the environment temperature before using it.

### User obligations

The user of the instrument must ensure that the following regulations and directives concerning the handling of hazardous materials are complied with:

- CEE directives on job safety
- National laws on job safety
- Accident prevention regulations
- Security data from the manufacturers of chemical substances.

## HD22.2 LABORATORY ELECTRODE HOLDER WITH MAGNETIC STIRRER

### HD22.3 LABORATORY ELECTRODE HOLDER









#### HD22.2

The HD22.2 is a laboratory electrode holder with an ultra slim magnetic stirrer. The height adjustable electrode holder supports two standard  $\varnothing$  12 mm electrodes. The stirring is performed by a small magnetic bar immersed in the liquid: the motion is generated by a rotary magnetic field controlled by microprocessor. There are no mechanically moving parts, therefore no maintenance is required.



The rotational speed can constantly be adjusted from 15 to 1500 rpm.

The HD22.2 has a modern and functional design. It is made of materials that resist to most chemical products.

#### Operation

- Insert the magnetic bar in the liquid container to be stirred.
- Power the stirrer by connecting the SWD10 power supply 12Vdc output (optional) or connecting it to the instrument's auxiliary supply output (series HD22xx.2) using the HD22.2.1 cable.
- Turn the instrument on with the  key.
- Set the rotational speed to the minimum by holding the  key, until the LED located between the  and  keys stops blinking.
- Now put the liquid container, at the center of the base.
- Set the desired rotational speed by pressing the  and  keys; during adjustment the LED located between the two keys is blinking.
- The  key allows to invert the magnetic bar rotation. The lit LED between the  and  keys, indicates that the inversion function is on; the rotation direction is automatically inverted every 30 seconds.

**The set speed and rotation direction remain in the memory also when the instrument is off. Upon power on, the rotation will progressively go back to the previously set speed.**

Note: if a non circular rotational motion begins, due to irregularities in the bottom of the container or the magnetic bar, use the  and  keys to restore a circular motion.

The electrode holder height can be adjusted. To set the desired height, press the button and slide the electrode holder along the staff.

#### HD22.3

The HD22.3 is a laboratory staff and electrode holder. Its height and depth can be adjusted. It can hold up to 5 standard  $\varnothing$  12 mm electrodes. The solid, fire-coated metal base, ensures stability even with 5 electrodes. The staff is fitted with hooks for cables and electrodes.

## Technical Information

	HD22.2	HD22.3
Power	12Vdc, 200mA	---
Stirring speed	15...1500 rpm	---
Stirring capacity	Max. 1000 ml	---
Stirring magnetic bar	L = 30...40 mm	---
Material	Body ABS; staff AISI 304	Body ABS; staff Fe 360
Weight	1150 g	1900 g
Bearing surface	Ø 100 mm	---
Dimensions	Base: 215x145x25 mm Staff: height 380 mm	Height max. 450 mm.
Environment temperature, % RH	0...50 °C, max. 85% RH without condensation	
No. of housings for the electrodes	Up to four Ø 12 mm electrodes and one Ø 4.5 mm breakable to Ø 12 mm	
Protection degree	IP65	



**HD22.2**



**HD22.3**

## COMMON TECHNICAL CHARACTERISTICS OF THE HD22... SERIES

### *Instrument*

Dimensions (Length x Width x Height)	265x190x75mm
Weight	1300 g
Materials	ABS, rubber
Display	Backlit, Dot Matrix. 240x64 points, visible area: 128x35mm

### *Operating conditions*

Operating temperature	-5...50°C
Warehouse temperature	-25...65°C
Working relative humidity	0...90% RH without condensation

**Protection degree** **IP66**

### *Power*

Mains adapter (code SWD10)	12Vdc/1A
Auxiliary supply output socket	12Vdc/200mA to power the HD22.2 electrode holder with built-in magnetic stirrer

### *Security of stored data*

Unlimited

### *Time*

Date and time	Real time clock with 3.6V - ½AA backup battery
Accuracy	1min/month max departure

### *Measured values memorization*

Quantity	2000 screens
Storage interval	1s ... 999s

### *Storage of calibrations*

pH and dissolved Oxygen	Last 8 pH and dissolved Oxygen calibrations. The last 2 calibrations are stored in the probe's SICRAM memory.
Conductivity	The last calibration is saved in the probe's SICRAM memory or in the instrument memory if the probe is without SICRAM.

### *RS232C serial interface*

Type	RS232C electrically isolated
Baud rate	Can be set from 1200 to 115200 baud
Data bit	8
Parity	None
Stop bit	1
Flow Control	Xon/Xoff
Serial cable length	Max. 15 m

### *USB interface*

Type	1.1 - 2.0 electrically isolated
------	---------------------------------

## HD2259.2 TECHNICAL CHARACTERISTICS

### pH - mV - MG/L O<sub>2</sub> - %O<sub>2</sub> - MBAR - °C - °F MEASUREMENT

<i>Measured quantities</i>	pH - mV mg/l O <sub>2</sub> - %O <sub>2</sub> - mbar °C - °F;
<i>Connections</i>	
Input for the temperature probes with SICRAM module ⑤	8-pole male DIN45326 connector
pH/mV inputs ①	Female BNC
Socket for the reference electrode	∅ 4mm standard plug
pH/ temperature input with SICRAM module ③	8-pole male DIN45326 connector
Dissolved Oxygen input ⑥	8-pole male DIN45326 connector
Serial interface	DB9 connector (male 9-pole)
USB interface	USB connector type B
Mains power supply	2-pole connector (∅5.5mm-2.1mm). Positive at centre
Power supply socket for the electrode holder with built-in magnetic stirrer	2-pole connector (∅5.5mm-2.1mm). Positive at centre (12Vdc/200mA output).
<i>Measurement of pH by Instrument</i>	
Measurement range	-9,999...+19.999pH
Resolution	0.01 or 0.001pH selectable from menu
Accuracy	±0.001pH ±1digit
Input impedance	>10 <sup>12</sup> Ω
Calibration error @25°C	Offset  > 20mV Slope > 63mV/pH or Slope < 50mV/pH Sensitivity > 106.5% or Sensitivity < 85%
Calibration points	Up to 5 points selected among 13 automatically detected buffer solutions
Temperature compensation	-50...150°C
Standard solutions detected automatically @25°C	1.679pH - 2.000pH - 4.000pH - 4.008pH - 4.010pH - 6.860pH - 6.865pH - 7.000pH - 7.413pH - 7.648pH - 9.180pH - 9.210pH - 10.010pH
<i>Measurement of mV by Instrument</i>	
Measurement range	-1999.9...+1999.9mV
Resolution	0.1mV
Accuracy	±0.1mV ±1digit
Drift after 1 year	0.5mV/year

### *Measurement of the concentration of dissolved Oxygen*

Measurement range	0.00...90.00mg/l
Resolution	0.01mg/l
Accuracy	$\pm 0.03\text{mg/l} \pm 1\text{digit}$ (60...110%, 1013mbar, 20...25°C)

### *Measurement of the saturation index of dissolved Oxygen*

Measurement range	0.0...600.0%
Resolution	0.1%
Accuracy	$\pm 0.3\% \pm 1\text{digit}$ (in the range 0.0...199.9%) $\pm 1\% \pm 1\text{digit}$ (in the range 200.0...600.0%)

### *Automatic temperature compensation*

0...50°C

### *Measurement of barometric pressure*

Measurement range	0.0...1100.0mbar
Resolution	0.1mbar
Accuracy	$\pm 2\text{mbar} \pm 1\text{digit}$ between 18 and 25°C $\pm (2\text{mbar} + 0.1\text{mbar}/^\circ\text{C})$ in the remaining range

### *Setting the salinity*

Setting	Direct in the menu, or automatic by conductivity measurement
Measurement range	0.0...70.0g/l
Resolution	0.1g/l

### *Temperature measurement with the sensor inside the dissolved oxygen probe*

Measurement range	0.0...45.0°C
Resolution	0.1°C
Accuracy	$\pm 0.1^\circ\text{C}$ (excluding probe error)
Drift after 1 year	0.1°C/year (only the instrument)

### *Temperature measurement with Pt100/Pt1000 probe*

Pt100 measurement range	-50...+150°C
Pt1000 measurement range	-50...+150°C
Resolution	0.1°C
Accuracy	$\pm 0.1^\circ\text{C} \pm 1\text{digit}$ (excluding probe error)
Drift after 1 year	0.1°C/year (only the instrument)

## HD22569.2 TECHNICAL CHARACTERISTICS

### PH - mV - X - $\Omega$ - TDS - NaCl - mg/L O<sub>2</sub> - %O<sub>2</sub> - mBar - °C - °F MEASUREMENT

#### *Measured quantities*

pH - mV  
 $\chi$  -  $\Omega$  - TDS - NaCl  
 mg/l O<sub>2</sub> - %O<sub>2</sub> - mbar  
 °C - °F;

#### *Connections*

Input for the temperature probes with SICRAM module ⑤ pH/mV input ① Socket for the reference electrode pH/ temperature input with SICRAM module ③ 4-ring/2-ring conductivity direct input ⑧ SICRAM probes conductivity input ⑦ Dissolved Oxygen input ⑥ Serial interface USB interface Mains power supply  Power supply socket for the electrode holder with built-in magnetic stirrer	8-pole male DIN45326 connector Female BNC Ø 4mm standard plug 8-pole male DIN45326 connector 8-pole male DIN45326 connector 8-pole male DIN45326 connector 8-pole male DIN45326 connector DB9 connector (male 9-pole) USB connector type B 2-pole connector (Ø5.5mm-2.1mm). Positive at centre  2-pole connector (Ø5.5mm-2.1mm). Positive at centre (12Vdc/200mA max. output).
---	--

#### *Measurement of pH by Instrument*

Measurement range Resolution Accuracy Input impedance Calibration error @25°C  Calibration points  Temperature compensation Standard solutions detected automatically @25°C	-9,999...+19.999pH 0.01 or 0.001pH selectable from menu ±0.001pH ±1digit >10 <sup>12</sup> $\Omega$  Offset  > 20mV Slope > 63mV/pH or Slope < 50mV/pH Sensitivity > 106.5% or Sensitivity < 85% Up to 5 points selected among 13 automatically detected buffer solutions -50...150°C  1.679pH - 2.000pH - 4.000pH - 4.008pH - 4.010pH - 6.860pH - 6.865pH - 7.000pH - 7.413pH - 7.648pH - 9.180pH - 9.210pH - 10.010pH
---	---

*Measurement of mV by Instrument*

Measurement range	-1999.9...+1999.9mV
Resolution	0.1mV
Accuracy	±0.1mV ±1digit
Drift after 1 year	0.5mV/year

*Measurement of conductivity by Instrument*

Measurement range (Kcell=0.01) / Resolution	0.000...1.999μS/cm / 0.001μS/cm
Measurement range (Kcell=0.1) / Resolution	0.00...19.99μS/cm / 0.01μS/cm
Measurement range (Kcell=1) / Resolution	0.0...199.9μS/cm / 0.1μS/cm
	200...1999μS/cm / 1μS/cm
	2.00...19.99mS/cm / 0.01mS/cm
	20.0...199.9mS/cm / 0.1mS/cm
Measurement range (Kcell=10) / Resolution	200...1999mS/cm / 1mS/cm
Accuracy (conductivity)	±0.5% ±1digit

*Measurement of resistivity by Instrument*

Measurement range (Kcell=0.01) / Resolution	Up to 1GΩ·cm / (*)
Measurement range (Kcell=0.1) / Resolution	Up to 100MΩ·cm / (*)
Measurement range (Kcell=1) / Resolution	5.0...199.9Ω·cm / 0.1Ω·cm
	200...999Ω·cm / 1Ω·cm
	1.00k...19.99kΩ·cm / 0.01kΩ·cm
	20.0k...99.9kΩ·cm / 0.1kΩ·cm
	100k...999kΩ·cm / 1kΩ·cm
	1...10MΩ·cm / 1MΩ·cm
Measurement range (Kcell=10) / Resolution	0.5...5.0Ω·cm / 0.1Ω·cm
Accuracy (resistivity)	±0.5% ±1digit

(\*) The resistivity measurement is obtained from the reciprocal of conductivity measurement. Close to the bottom of the scale, the indication of resistivity appears like reported in the table below.

<b>K cell = 0.01 cm<sup>-1</sup></b>		<b>K cell = 0.1 cm<sup>-1</sup></b>	
Conductivity (μS/cm)	Resistivity (MΩ·cm)	Conductivity (μS/cm)	Resistivity (MΩ·cm)
0.001 μS/cm	1000 MΩ·cm	0.01 μS/cm	100 MΩ·cm
0.002 μS/cm	500 MΩ·cm	0.02 μS/cm	50 MΩ·cm
0.003 μS/cm	333 MΩ·cm	0.03 μS/cm	33 MΩ·cm
0.004 μS/cm	250 MΩ·cm	0.04 μS/cm	25 MΩ·cm
...	...	...	...



*Measurement of total dissolved solids (with coefficient  $\chi/TDS=0.5$ )*

Measurement range (Kcell=0.01) / Resolution	0.00...1.999mg/l / 0.005mg/l
Measurement range (Kcell=0.1) / Resolution	0.00...19.99mg/l / 0.05mg/l
Measurement range (Kcell=1) / Resolution	0.0...199.9 mg/l / 0.5 mg/l
	200...1999 mg/l / 1 mg/l
	2.00...19.99 g/l / 0.01 g/l
	20.0...199.9 g/l / 0.1 g/l
Measurement range (Kcell=10) / Resolution	100...999 g/l / 1 g/l
Accuracy (total dissolved solids)	$\pm 0.5\%$ $\pm 1$ digit

*Measurement of salinity*

Measurement range / Resolution	0.000...1.999g/l / 1mg/l
	2.00...19.99g/l / 10mg/l
	20.0...199.9 g/l / 0.1 g/l
Accuracy (salinity)	$\pm 0.5\%$ $\pm 1$ digit

*Automatic/manual temperature compensation*

0...100°C with  $\alpha_T = 0.00...4.00\%/^{\circ}\text{C}$

*Reference temperature*

0...50°C (**default 20°C or 25°C**)

*$\chi/TDS$  conversion factor*

0.4...0.8

*Preset cell constant  $K$  ( $\text{cm}^{-1}$ )*

0.01 - 0.1 - 0.5 - 0.7 - 1.0 - 10.0

*Cell constant  $K$  ( $\text{cm}^{-1}$ ) that can be set by the user*

0.01...20.00

*Standard solutions automatically detected (@25°C)*

147 $\mu\text{S}/\text{cm}$   
1413 $\mu\text{S}/\text{cm}$   
12880 $\mu\text{S}/\text{cm}$   
111800 $\mu\text{S}/\text{cm}$

*Measurement of the concentration of dissolved Oxygen*

Measurement range	0.00...90.00mg/l
Resolution	0.01mg/l
Accuracy	$\pm 0.03\text{mg/l} \pm 1$ digit (60...110%, 1013mbar, 20...25°C)

*Measurement of the saturation index of dissolved Oxygen*

Measurement range	0.0...600.0%
Resolution	0.1%
Accuracy	$\pm 0.3\%$ $\pm 1$ digit (in the range 0.0...199.9%) $\pm 1\%$ $\pm 1$ digit (in the range 200.0...600.0%)

*Measurement of barometric pressure*

Measurement range	0.0...1100.0mbar
Resolution	0.1mbar
Accuracy	$\pm 2\text{mbar} \pm 1$ digit between 18 and 25°C $\pm (2\text{mbar} + 0.1\text{mbar}/^{\circ}\text{C})$ in the remaining range

*Setting the salinity*

Setting	Direct in the menu, or automatic by conductivity measurement
Measurement range	0.0...70.0g/l
Resolution	0.1g/l

*Temperature measurement with the sensor inside the dissolved oxygen probe*

Measurement range	0.0...45.0°C
Resolution	0.1°C
Accuracy	±0.1°C (excluding probe error)
Drift after 1 year	0.1°C/year (only the instrument)

*Automatic temperature compensation*

0...50°C

*Temperature measurement with Pt100/Pt1000 probe*

Pt100 measurement range	-50...+150°C
Pt1000 measurement range	-50...+150°C
Resolution	0.1°C
Accuracy	±0.1°C ±1digit (excluding probe error)
Drift after 1 year	0.1°C/year (only the instrument)

## TECHNICAL DATA OF PROBES IN LINE WITH THE INSTRUMENTS HD22... SERIES

### HD2259.2 AND HD22569.2 pH ELECTRODES ① ②

#### *pH electrodes without SICRAM module*

ORDER CODE	MEASUREMENT RANGE AND USE	DIMENSIONS
<b>KP20</b>	0...14pH / 0...80°C / 3bar Glass body- GEL 1 diaphragm in ceramic Waste water, drinking water, colours, aqueous emulsions, electroplating waters, fruit-juices, stock waters, titration, varnishes.	
<b>KP30</b>	0...14pH / 0...80°C / 3bar Glass body- GEL 1 diaphragm in ceramic Cable L=1m with BNC Waste water, drinking water, aqueous emulsions, electroplating waters, colours, varnishes, stock waters, fruit-juices, titration.	
<b>KP50</b>	0...14pH / 0...80°C / 3bar Glass body- GEL 1 Teflon ring diaphragm Varnishes, cosmetics, aqueous emulsions, electroplating waters, creams, deionised water, TRIS buffer, drinking water, stock waters, fruit-juices, low ionic content solutions, mayonnaise, preserved foods, colours, titration, titration in non water solutions, stock waters, soaps, waste water, viscous samples.	
<b>KP61</b>	2...14pH / 0...80°C / 3bar Body in glass Liquid reference 3 diaphragms in ceramic Waste water, dough, bread, fruit-juices, varnishes, cosmetics, creams, deionised water, drinking water, aqueous emulsions, electroplating waters, soaps yogurt, milk, titration, titration in non water solutions, stock waters, mayonnaise, wine, low ionic content solutions, butter, protein samples, colours, viscous samples.	

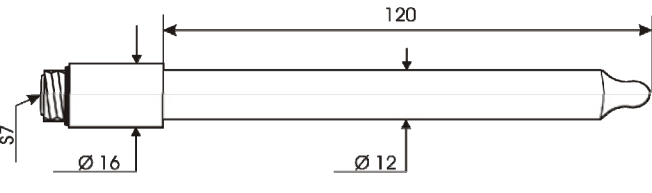
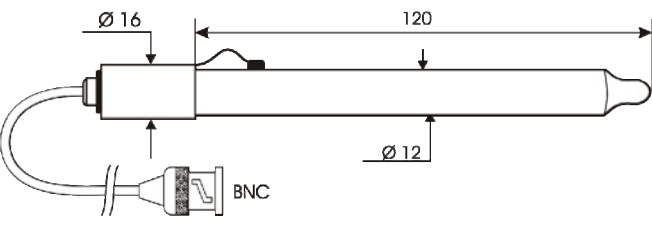
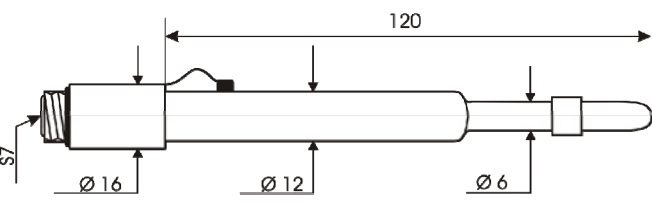
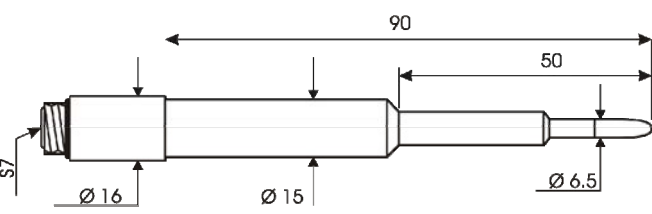
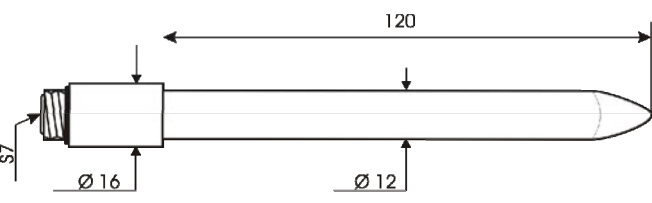
ORDER CODE	MEASUREMENT RANGE AND USE	DIMENSIONS
<b>KP62</b>	0...14pH / 0...80°C / 3bar Glass body- GEL 1 diaphragm in ceramic Colours, varnishes, drinking water, aqueous emulsions, fruit-juices, electroplating waters, stock waters, titration, waste water.	
<b>KP63</b>	0...14pH / 0...80°C / 1bar Body in glass Liquid reference KCl 3M 1 diaphragm in ceramic Cable L=1m with BNC Colours, varnishes, drinking water, aqueous emulsions, fruit-juices, electroplating waters, stock waters, titration, waste water.	
<b>KP64</b>	0...14pH / 0...80°C / 0.1bar Body in glass Liquid reference KCl 3M Teflon ring diaphragm Colours, varnishes, cosmetics, creams, deionised water, drinking water, aqueous emulsions, fruit-juices, soaps, low ionic content solutions, mayonnaise, preserved foods, stock waters, titration, titration in non water solutions, TRIS buffer, waste water, viscous samples, wine.	
<b>KP70</b>	2...14pH / 0...50°C / 0.1bar Glass body- GEL 1 open hole Dough, bread, colours, varnishes, creams, drinking water, aqueous emulsions, fruit-juices, electroplating waters, soaps, mayonnaise, preserved foods, cheese, milk, stock waters, viscous samples, waste water, butter, yogurt.	
<b>KP80</b>	2...14pH / 0...60°C / 1bar Glass body- GEL 1 open hole Dough, bread, colours, varnishes, cosmetics, creams, drinking water, aqueous emulsions, fruit-juices, electroplating waters, soaps, mayonnaise, preserved foods, stock waters, titration, titration in non water solutions, viscous samples, waste water, yogurt, milk, butter.	

*pH electrodes with SICRAM module* ③ ④

ORDER CODE	MEASUREMENT RANGE AND USE	DIMENSIONS
<b>KP63TS</b>	<p>0...14pH / 0...80°C / 1bar                      Body in glass.                      Pt100 sensor.                      Liquid reference KCl 3M                      1 diaphragm in ceramic                      Cable L = 1m                      Colours, varnishes, drinking water,                      aqueous emulsions, fruit-juices,                      electroplating waters, stock waters,                      titration, waste water.</p>	
<b>KP47</b>	<p>Please see the technical characteristics of the electrode connected to the module.</p>	<p><b>BNC</b></p>

**HD2259.2 AND HD22569.2 REDOX ELECTRODES** ① ①

ORDER CODE	MEASUREMENT RANGE AND USE	DIMENSIONS
<b>KP90</b>	<p>±2000mV                      0...80°C                      5 bar                      Body in glass                      Liquid reference                      KCl 3M                      General use</p>	
<b>KP91</b>	<p>±1000mV                      0...60°C                      1 bar                      Glass body- GEL                      Cable L=1m with BNC                      General use                      Not heavy duty</p>	

**2 AND 4 ELECTRODES CONDUCTIVITY PROBES FOR HD22569.2**

ORDER CODE	MEASUREMENT RANGE AND USE	DIMENSIONS
<b>Conductivity probes without SICRAM module ⑧</b>		
<p align="center"><b>SPO6T</b></p>	<p align="center">K=0.7 5µS/cm ...20mS/cm 0...90°C Platinum 4-electrode cell Pocan probe material General use Not heavy duty Pt100 sensor</p>	
<p align="center"><b>SPT401.001</b></p>	<p align="center">K=0.01 0.04µS/cm ...20µS/cm 0...120°C 2-electrode cell AISI 316 Ultrapure water Closed-cell measurement Pt100 sensor</p>	
<p align="center"><b>SPT01G</b></p>	<p align="center">K=0.1 0.1µS/cm ...500µS/cm 0...80°C 2-electrode cell in Platinum wire Glass probe material Pure water Pt100 sensor</p>	
<p align="center"><b>SPT1G</b></p>	<p align="center">K=1 10µS/cm ...10mS/cm 0...80°C 2-electrode cell in Platinum wire Glass probe material General heavy duty use, medium conductivity Pt100 sensor</p>	
<p align="center"><b>SPT10G</b></p>	<p align="center">K=10 500µS/cm ...200mS/cm 0...80°C 2-electrode cell in Platinum wire Glass probe material General heavy duty use, high conductivity Pt100 sensor</p>	
<b>Conductivity probes with SICRAM module ⑦</b>		
<p align="center"><b>SPT1GS</b></p>	<p align="center">K=1 10µS/cm ...10mS/cm 0...80°C 2-electrode cell in Platinum wire Glass probe material General heavy duty use, medium conductivity Pt100 sensor</p>	

**DISSOLVED OXYGEN PROBES FOR HD2259.2 AND HD22569.2 ©**

<i>Model</i>	<b>DO9709 SM</b>	<b>DO9709 SM.5</b>
<i>Type</i>	Polarographic probe: Ag/AgCl anode, Platinum cathode	
<i>O<sub>2</sub> measuring range</i>	0...40 mg/l; 0...400% air saturation	
<i>Temperature measuring range</i>	-5...45 °C	
<i>Temperature sensor</i>	Pt1000	
<i>Accuracy</i>	± 1% f.s.	
<i>Response time in N<sub>2</sub></i>	t <sub>90</sub> < 30 s	
<i>Flow rate</i>	> 9 cm/s	
<i>Minimum immersion depth</i>	30 mm	
<i>Membrane</i>	Replaceable	
<i>Cable length</i>	2 m	5 m
<i>Dimensions</i>		

<i>Model</i>	<b>DO9709 SG</b>	<b>DO9709 SG.4</b>
<i>Type</i>	Galvanic probe: Lead anode, Platinum cathode	
<i>O<sub>2</sub> measuring range</i>	0...60 mg/l; 0...600% air saturation	
<i>Temperature measuring range</i>	-5...50 °C	
<i>Temperature sensor</i>	NTC	
<i>Accuracy</i>	± 2% f.s.	
<i>Response time</i>	90% in 10 s (changes with temperature)	
<i>Flow rate</i>	> 20 cm/s	
<i>Life time</i>	≥ 3 years (depending on application and maintenance)	
<i>Maximum pressure</i>	3 bar	
<i>Operating temperature</i>	0...+40 °C	
<i>Storage temperature</i>	0...+60 °C	
<i>Membrane</i>	Replaceable	
<i>Cable length</i>	2 m	4 m
<i>Dimensions</i>		

Model	DO9709 SS	DO9709 SS.5	DO9709 SS.1	DO9709 SS.5.1
Type	Polarographic probe, Silver anode, Platinum cathode		Galvanic probe, Zinc anode, Silver cathode	
Range O <sub>2</sub>	0.00...60.00mg/l		0.00...20.00mg/l	
Operating temperature	0...45°C		0...50°C	
Accuracy	±1% f.s.		±2% f.s.	
Membrane	Replaceable		Replaceable	
Cable length	2m	5m <sup>(*)</sup>	2m	5m <sup>(*)</sup>

(\*) Cable with connector

<b>DO9709SS</b>	
<b>DO9709SS.5</b>	
<b>DO9709SS.1</b>	
<b>DO9709SS.5.1</b>	



## TEMPERATURE PROBES

### Temperature probes Pt100 using SICRAM module ⑤

Model	Type	Application range	Accuracy
<b>TP472I</b>	Immersion	-196°C...+500°C	±0.25°C (-196°C...+300°C) ±0.5°C (+300°C...+500°C)
<b>TP472I.0</b> 1/3 DIN - Thin Film	Immersion	-50°C...+300°C	±0.25°C
<b>TP473P.I</b>	Penetration	-50°C...+400°C	±0.25°C (-50°C...+300°C) ±0.5°C (+300°C...+400°C)
<b>TP473P.0</b> 1/3 DIN - Thin Film	Penetration	-50°C...+300°C	±0.25°C
<b>TP474C.I</b>	Contact	-50°C...+400°C	±0.3°C (-50°C...+300°C) ±0.5°C (+300°C...+400°C)
<b>TP474C.0</b> 1/3 DIN - Thin Film	Contact	-50°C...+300°C	±0.3°C
<b>TP475A.0</b> 1/3 DIN - Thin Film	Air	-50°C...+250°C	±0.3°C
<b>TP472I.5</b>	Immersion	-50°C...+400°C	±0.3°C (-50°C...+300°C) ±0.6°C (+300°C...+400°C)
<b>TP472I.10</b>	Immersion	-50°C...+400°C	±0.3°C (-50°C...+300°C) ±0.6°C (+300°C...+400°C)
<b>TP49A.O</b> Class A - Thin Film	Immersion	-70°C...+250°C	±0.25°C
<b>TP49AC.O</b> Class A - Thin Film	Contact	-70°C...+250°C	±0.25°C
<b>TP49AP.O</b> Class A - Thin Film	Penetration	-70°C...+250°C	±0.25°C
<b>TP875.I</b>	Globe-thermometer Ø 150 mm	-30°C...+120°C	±0.25°C
<b>TP876.I</b>	Globe-thermometer Ø 50 mm	-30°C...+120°C	±0.25°C
<b>TP87.O</b> 1/3 DIN - Thin Film	Immersion	-50°C...+200°C	±0.25°C
<b>TP878.O</b> 1/3 DIN - Thin Film	Photovoltaic	+4°C...+85°C	±0.25°C
<b>TP878.1.O</b> 1/3 DIN - Thin Film	Photovoltaic	+4°C...+85°C	±0.25°C
<b>TP879.O</b> 1/3 DIN - Thin Film	Compost	-20°C...+120°C	±0.25°C

Temperature drift @ 20°C

0.003%/°C

#### 4 wire Pt100 and 2 wire Pt1000 probes with TP47module ⑤

Model	Type	Application range	Accuracy
<b>TP47.100.O</b> 1/3 DIN – Thin Film	Pt100 4 wires	-50...+250°C	1/3 DIN
<b>TP47.1000.O</b> 1/3 DIN – Thin Film	Pt1000 2 wires	-50...+250°C	1/3 DIN
<b>TP87.100.O</b> 1/3 DIN – Thin Film	Pt100 4 wires	-50...+200°C	1/3 DIN
<b>TP87.1000.O</b> 1/3 DIN – Thin Film	Pt1000 2 wires	-50...+200°C	1/3 DIN

Temperature drift @ 20°C

Pt100	0.003%/°C
Pt1000	0.005%/°C

## ORDER CODES THE HD22... SERIES INSTRUMENTS

- HD2259.2** The kit is composed of: instrument HD2259.2, performs measurements of pH - redox - dissolved Oxygen concentration - saturation index - temperature, **datalogger**, stabilized power supply with  $V_{in}=100-240V_{ac}/12V_{dc}-1A$  (SWD10), operating manual, case and DeltaLog11 software (downloadable from Delta OHM website).
- HD22569.2** The kit is composed of: instrument HD22569.2, performs measurements of pH - redox - conductivity - resistivity - TDS - salinity - dissolved Oxygen concentration - saturation index - temperature, **datalogger**, stabilized power supply with  $V_{in}=100-240V_{ac}/12V_{dc}-1A$  (SWD10), operating manual, case and DeltaLog11 software (downloadable from Delta OHM website).

**pH/mV electrodes, conductivity probes, dissolved oxygen probes, temperature probes, standard reference solutions for different measurement types, connection cables for pH electrodes with S7 connector, serial and USB cables for data download to PC or printer have to be ordered separately.**

## COMMON ACCESSORIES FOR THE HD22... SERIES INSTRUMENTS

- 9CPRS232** Connection cable with sub D 9-pole female connectors for RS232C.
- CP22** Connection cable USB 2.0 connector type A on one end, connector type B on the other end.
- DeltaLog11** CD-ROM of DeltaLog11 software for download and management of the data on PC. For Windows (from 98) operating systems.
- SWD10** Stabilized power supply at 100-240Vac/12Vdc-1A mains voltage.
- HD40.1** The kit includes: 24-column portable thermal printer, serial interface, 57mm paper width, four NiMH 1.2V rechargeable batteries, SWD10 power supply, instruction manual, 5 thermal paper rolls.
- BAT.40** Spare battery pack for HD40.1 printer with in-built temperature sensor.
- RCT** The kit includes 4 thermal paper rolls 57mm wide and 32mm in diameter.
- HD22.2** Laboratory electrode holder composed of basis plate with incorporated magnetic stirrer, staff and replaceable electrode holder. Height max. 380mm. For  $\varnothing 12$ mm electrodes.
- HD22.2.1** Power connection cable from a HD22xx.2 series instrument.
- HD22.3** Laboratory electrode holder with metal base. Electrode holder with flexible arm for free positioning. For  $\varnothing 12$ mm electrodes.

**ACCESSORIES FOR THE HD2259.2 AND HD22569.2 INSTRUMENTS  
WITH INPUT FOR pH MEASUREMENT**

***pH ELECTRODES WITHOUT SICRAM MODULE (INPUTS ① AND ②)***

---

<b>KP20</b>	Combined general use pH electrode, gel-filled, with screw connector S7, body in Epoxy.
<b>KP30</b>	Combined general use pH electrode, gel-filled, 1m cable with BNC, body in Epoxy.
<b>KP50</b>	Combined pH electrode for general use, varnishes, emulsions, gel-filled, with screw connector S7, body in glass.
<b>KP61</b>	Combined pH electrode, 3 diaphragms for milk, cream, etc. with screw connector S7, body in glass.
<b>KP62</b>	Combined pH electrode, 1 diaphragm for pure water, paints, etc. gel-filled, with screw connector S7, body in glass.
<b>KP63</b>	Combined pH electrode for general use, varnishes, 1 m cable with BNC, KCl 3M electrolyte, body in glass.
<b>KP64</b>	Combined pH electrode for water, varnishes, emulsions, etc. with screw connector S7, KCl 3M electrolyte, body in glass.
<b>KP70</b>	Combined pH electrode, micro Ø 6.5mm, gel-filled, for milk, bread, cheese, etc. with screw connector S7, body in glass.
<b>KP80</b>	Combined pointed pH electrode, gel-filled, with screw connector S7, body in glass.
<b>CP</b>	Extension cable 1.5m with BNC connectors on one side and S7 on the other side for electrode, without cable, with S7 connector.
<b>CP5</b>	Extension cable 5m with BNC connectors on one side and S7 on the other side for electrode, without cable, with S7 connector.
<b>CE</b>	Screw connector S7 for pH electrode.
<b>BNC</b>	Female BNC for electrode extension.

***pH ELECTRODES WITH SICRAM MODULE (INPUT ③)***

---

<b>KP63TS</b>	Combined pH/temperature electrode, Pt100 sensor, with SICRAM module, body in glass.
---------------	---

***SICRAM MODULE WITH BNC INPUT FOR pH ELECTRODES (INPUT ③)***

---

<b>KP47</b>	SICRAM module with BNC input for pH electrode.
-------------	--

### *ORP ELECTRODES (INPUTS ① AND ②)*

---

<b>KP90</b>	REDOX PLATINUM electrode for general use, with screw connector S7, KCl 3M electrolyte, body in glass.
<b>KP91</b>	REDOX PLATINUM electrode for general non heavy duty use, gel-filled, 1m cable with BNC, body in Epoxy.

### *pH STANDARD SOLUTIONS*

---

<b>HD8642</b>	Buffer solution 4.01pH - 200cc.
<b>HD8672</b>	Buffer solution 6.86pH - 200cc.
<b>HD8692</b>	Buffer solution 9.18pH - 200cc.

### *REDOX STANDARD SOLUTIONS*

---

<b>HDR220</b>	Redox buffer solution 220mV 0.5 l.
<b>HDR468</b>	Redox buffer solution 468mV 0.5 l.

### *ELECTROLYTE SOLUTIONS*

---

<b>KCL 3M</b>	50ml ready solution for electrode refilling.
---------------	--

### *MAINTENANCE AND CLEANING*

---

<b>HD62PT</b>	Diaphragm cleaning solution (Tiourea in HCl) – 200ml.
<b>HD62PP</b>	Diaphragm cleaning solution (Pepsina in HCl) – 200ml.
<b>HD62RF</b>	Electrode regeneration solution (Fluorhydric Acid) – 100ml.
<b>HD62SC</b>	Electrode preservation solution – 200ml.

**ACCESSORIES FOR THE HD22569.2 INSTRUMENT  
WITH CONDUCTIVITY INPUT**

**CONDUCTIVITY AND COMBINED CONDUCTIVITY/TEMPERATURE PROBES  
WITHOUT SICRAM MODULE (INPUT Ⓢ)**

---

<b>SP06T</b>	Conductivity/temperature combined probe, 4-electrode cell in Platinum, body in POCAN. Cell constant K = 0.7. Measuring range 5µS/cm ...20mS/cm, 0...90°C.
<b>SPT401.001</b>	Conductivity/temperature combined probe, 2-electrode cell in AISI 316 steel. Cell constant K 0.01. Measuring range 0.04µS/cm ...20µS/cm, 0...120°C.
<b>SPT01G</b>	Conductivity/temperature combined probe 2-electrode cell in Platinum wire, body in glass. Cell constant K = 0.1. Measuring range 0.1µS/cm ...500µS/cm, 0...80°C.
<b>SPT1G</b>	Conductivity/temperature combined probe 2-electrode cell in Platinum wire, body in glass. Cell constant K = 1. Measuring range 10µS/cm ...10mS/cm, 0...80°C.
<b>SPT10G</b>	Conductivity/temperature combined probe 2-electrode cell in Platinum wire, body in glass. Cell constant K = 10. Measuring range 500µS/cm ...200mS/cm, 0...80°C.

**CONDUCTIVITY/TEMPERATURE COMBINED PROBES WITH SICRAM MODULE (INPUT Ⓣ)**

---

<b>SPT1GS</b>	Conductivity/temperature combined probe 2-electrode cell in Platinum wire, body in glass, with SICRAM module. Cell constant K = 1. Measuring range 10µS/cm...10mS/cm, 0...80°C.
---------------	---

**STANDARD CONDUCTIVITY CALIBRATION SOLUTIONS**

---

<b>HD8747</b>	Standard calibration solution 0.001 mol/l equal to 147µS/cm @25°C - 200cc.
<b>HD8714</b>	Standard calibration solution 0.01 mol/l equal to 1413µS/cm @25°C - 200cc.
<b>HD8712</b>	Standard calibration solution 0.1 mol/l equal to 12880µS/cm @25°C - 200cc.
<b>HD87111</b>	Standard calibration solution 1 mol/l equal to 111800µS/cm @25°C - 200cc.

**ACCESSORIES FOR THE HD2259.2 AND HD22569.2 INSTRUMENTS  
WITH INPUT FOR DISSOLVED OXYGEN MEASUREMENT**

*COMBINED DISSOLVED OXYGEN/TEMPERATURE PROBES (INPUT ©)*

---

- DO9709 SM**     **Polarographic** combined probe for measurement of O<sub>2</sub> and temperature with replaceable membrane. The kit includes: probe, one spare membrane, zero solution, electrolyte solution and DO9709/20 calibrator. Cable length 2 m. Dimensions Ø 12 mm x 120 mm.
- DO9709 SM.5**     **Polarographic** combined probe for measurement of O<sub>2</sub> and temperature with replaceable membrane. The kit includes: probe, one spare membrane, zero solution, electrolyte solution and DO9709/20 calibrator. Cable length 5 m. Dimensions Ø 12 mm x 120 mm.
- DO9709 SG**     **Galvanic** combined probe for measurement of O<sub>2</sub> and temperature with replaceable membrane. The kit includes: probe, one spare membrane, zero solution, electrolyte solution and DO9709/20 calibrator. Cable length 2 m. Dimensions Ø 12 mm x 100 mm.
- DO9709 SG.4**     **Galvanic** combined probe for measurement of O<sub>2</sub> and temperature with replaceable membrane. The kit includes: probe, one spare membrane, zero solution, electrolyte solution and DO9709/20 calibrator. Cable length 4 m. Dimensions Ø 12 mm x 100 mm.
- DO9709 SS**     **Polarographic** combined probe for measurement of O<sub>2</sub> and temperature with replaceable membrane. The kit includes: probe, two membranes, zero solution, electrolyte solution and DO9709/20 calibrator. Cable length 2 m. Dimensions Ø 12 mm x 120 mm.
- DO9709 SS.5**     **Polarographic** combined probe for measurement of O<sub>2</sub> and temperature with connector, replaceable membrane. The kit includes: probe, two membranes, zero solution, electrolyte solution and DO9709/20 calibrator. Cable length 5 m. Dimensions Ø 12 mm x 120 mm.
- DO9709 SS.1**     **Galvanic** combined probe for measurement of O<sub>2</sub> and temperature with replaceable membrane. The kit includes: probe, two membranes in total, zero solution, electrolyte solution and DO9709/21 calibrator. Cable length 1.6 m. Dimensions Ø 12 mm x 76 mm. Membrane holder Ø 16 mm.
- DO9709 SS.5.1**     **Galvanic** combined probe for measurement of O<sub>2</sub> and temperature with connector, replaceable membrane. The kit includes: probe, two membranes in total, zero solution, electrolyte solution and DO9709/21 calibrator. Cable length 5 m. Dimensions Ø 12 mm x 76 mm. Membrane holder Ø 16 mm.

*ACCESSORIES*

---

- DO9709 SMK**     Accessories kit for the DO9709 SM and DO9709 SM.5 probes consisting of one membrane, zero solution, 50 ml electrolyte solution.
- DO9701M**     50 ml electrolyte solution for DO9709 SM and DO9709 SM.5 polarographic probes.
- DO9709 SGK**     Accessories kit for the DO9709 SG and DO9709 SG.4 probes consisting of one membrane, zero solution, 100 ml electrolyte solution.
- DO9701G**     100 ml electrolyte solution for DO9709 SG and DO9709 SG.4 galvanic probes.

<b>DO9709 SSK</b>	Accessories kit for the DO9709 SS and DO9709 SS.5 probes consisting of three membranes, zero solution, electrolyte solution.
<b>DO9701</b>	Electrolyte solution for DO9709 SS and DO9709 SS.5 polarographic probes.
<b>DO9709/21K</b>	Accessories kit for the DO9709 SS.1 and DO9709 SS.5.1 galvanic probes consisting of three membranes, zero solution, electrolyte solution.
<b>DO9701.1</b>	Electrolyte solution for DO9709 SS.1 and DO9709 SS.5.1 galvanic probes.
<b>DO9709/20</b>	Calibrator for DO9709 SS, DO9709 SS.5, DO9709 SM, DO9709 SM.5 polarographic probes and DO9709 SG, DO9709 SG.4 galvanic probes.
<b>DO9709/21</b>	Calibrator for DO9709 SS.1 and DO9709 SS.5.1 galvanic probes.
<b>DO9700</b>	Zero oxygen solution.



**ACCESSORIES FOR THE HD22... SERIES INSTRUMENTS  
WITH INPUT FOR TEMPERATURE MEASUREMENT**

***TEMPERATURE PROBES COMPLETE WITH SICRAM MODULE (INPUT Ⓢ)***

---

<b>TP472I</b>	Immersion probe, sensor Pt100. Stem Ø 3 mm, length 300 mm. Cable length 2 metres.
<b>TP472I.0</b>	Immersion probe, sensor Pt100. Stem Ø 3 mm, length 230 mm. Cable length 2 metres.
<b>TP473P.I</b>	Penetration probe, sensor Pt100. Stem Ø 4mm, length 150 mm. Cable length 2 metres.
<b>TP473P.0</b>	Penetration probe, sensor Pt100. Stem Ø 4mm, length 150 mm. Cable length 2 metres.
<b>TP474C.0</b>	Contact probe, sensor Pt100. Stem Ø 4 mm, length 230 mm, contact surface Ø 5 mm. Cable length 2 metres.
<b>TP475A.0</b>	Air probe, sensor Pt100. Stem Ø 4 mm, length 230 mm. Cable length 2 metres.
<b>TP472I.5</b>	Immersion probe, sensor Pt100. Stem Ø 6 mm, length 500 mm. Cable length 2 metres.
<b>TP472I.10</b>	Immersion probe, sensor Pt100. Stem Ø 6 mm, length 1000 mm. Cable length 2 metres.
<b>TP49A.I</b>	Immersion probe, sensor Pt100. Stem Ø 2.7 mm, length 150 mm. Cable length 2 metres. Aluminium handle.
<b>TP49AC.I</b>	Contact probe, sensor Pt100. Stem Ø 4 mm, length 150 mm. Cable length 2 metres. Aluminium handle.
<b>TP49AP.I</b>	Penetration probe, sensor Pt100. Stem Ø 2.7 mm, length 150 mm. Cable length 2 metres. Aluminium handle.
<b>TP875.I</b>	Globe-thermometer Ø 150 mm with handle. Cable length 2 metres.
<b>TP876.I</b>	Globe-thermometer Ø 50 mm with handle. Cable length 2 metres.
<b>TP87.O</b>	Immersion probe, sensor Pt100. Stem Ø 3 mm, length 70 mm. Cable length 2 metres.
<b>TP878.O</b>	Contact probe for solar panels. Cable length 2 metres.
<b>TP878.1.O</b>	Contact probe for solar panels. Cable length 5 metres.
<b>TP879.O</b>	Penetration probe for compost. Stem Ø 8 mm, length 1 metre. Cable length 2 metres.

*TEMPERATURE PROBES COMPLETE WITH TP47 MODULE (INPUT ⑤)*

---

- TP47.100.O** Immersion probe, sensor Pt100 direct 4 wires. Probe's stem Ø 3mm, length 230mm. 4-wire connection cable with connector, length 2 metres.
- TP47.1000.O** Immersion probe, sensor Pt1000. Probe's stem Ø 3mm, length 230mm. 2-wire connection cable with connector, length 2 metres.
- TP87.100.O** Immersion probe, sensor Pt100 direct 4 wires. Probe's stem Ø 3mm, length 70mm. 4-wire connection cable with connector, length 2 metres.
- TP87.1000.O** Immersion probe, sensor Pt1000. Probe's stem Ø 3mm, length 70mm. 2-wire connection cable with connector, length 2 metres.

*COMMON ACCESSORIES FOR THE HD22... SERIES INSTRUMENTS*

---

- TP47** Module for connection to the HD22... series of the following probes: direct 4-wire Pt100, 2-wire Pt1000, **without electronic amplification and linearization.**

**DELTA OHM metrology laboratories LAT N° 124 are ISO/IEC 17025 accredited by ACCREDIA for Temperature, Humidity, Pressure, Photometry / Radiometry, Acoustics and Air Velocity. They can supply calibration certificates for the accredited quantities.**

**DICHIARAZIONE DI CONFORMITÀ UE  
EU DECLARATION OF CONFORMITY****Delta Ohm S.r.L. a socio unico – Via Marconi 5 – 35030 Caselle di Selvazzano – Padova – ITALY**Documento Nr. / Mese.Anno: **5112 / 06.2018**  
Document-No. / Month.Year :

Si dichiara con la presente, in qualità di produttore e sotto la propria responsabilità esclusiva, che i seguenti prodotti sono conformi ai requisiti di protezione definiti nelle direttive del Consiglio Europeo:

*We declare as manufacturer herewith under our sole responsibility that the following products are in compliance with the protection requirements defined in the European Council directives:*

Codice prodotto: **HD2259.2 – HD22569.2**  
Product identifier :Descrizione prodotto: **Misuratori da tavolo multiparametro**  
Product description : **Multiparameter bench-top meters**I prodotti sono conformi alle seguenti Direttive Europee:  
*The products conform to following European Directives:*

Direttive / Directives	
2014/30/EU	Direttiva EMC / EMC Directive
2014/35/EU	Direttiva bassa tensione / Low Voltage Directive
2011/65/EU	RoHS / RoHS

Norme armonizzate applicate o riferimento a specifiche tecniche:  
*Applied harmonized standards or mentioned technical specifications:*

Norme armonizzate / Harmonized standards	
EN 61010-1:2010	Requisiti di sicurezza elettrica / Electrical safety requirements
EN 61326-1:2013	Requisiti EMC / EMC requirements
EN 50581:2012	RoHS / RoHS

Il produttore è responsabile per la dichiarazione rilasciata da:  
*The manufacturer is responsible for the declaration released by:*

Johannes Overhues

Amministratore delegato  
Chief Executive Officer

Caselle di Selvazzano, 26/06/2018

Questa dichiarazione certifica l'accordo con la legislazione armonizzata menzionata, non costituisce tuttavia garanzia delle caratteristiche.

*This declaration certifies the agreement with the harmonization legislation mentioned, contained however no warranty of characteristics.*

# GUARANTEE

## TERMS OF GUARANTEE

All DELTA OHM instruments are subject to accurate testing, and are guaranteed for 24 months from the date of purchase. DELTA OHM will repair or replace free of charge the parts that, within the warranty period, shall be deemed non efficient according to its own judgement. Complete replacement is excluded and no damage claims are accepted. The DELTA OHM guarantee only covers instrument repair. The guarantee is void in case of incidental breakage during transport, negligence, misuse, connection to a different voltage than that required for the appliance by the operator. Finally, a product repaired or tampered by unauthorized third parties is excluded from the guarantee. The instrument shall be returned FREE OF SHIPMENT CHARGES to your dealer. The jurisdiction of Padua applies in any dispute.



The electrical and electronic equipment marked with this symbol cannot be disposed of in public landfills. According to the Directive 2011/65/EU, the european users of electrical and electronic equipment can return it to the dealer or manufacturer upon purchase of a new one. The illegal disposal of electrical and electronic equipment is punished with an administrative fine.

This guarantee must be sent together with the instrument to our service centre.

IMPORTANT: Guarantee is valid only if coupon has been correctly filled in all details.

Instrument Code:             HD2259.2             HD22569.2

Serial Number \_\_\_\_\_

## RENEWALS

Date \_\_\_\_\_

Date \_\_\_\_\_

Inspector \_\_\_\_\_

Inspector \_\_\_\_\_

Date \_\_\_\_\_

Date \_\_\_\_\_

Inspector \_\_\_\_\_

Inspector \_\_\_\_\_

Date \_\_\_\_\_

Date \_\_\_\_\_

Inspector \_\_\_\_\_

Inspector \_\_\_\_\_



The quality level of our instruments is the result of the constant development of the product. This may produce some differences between the information written in this manual and the instrument you have purchased. We cannot completely exclude the possibility of errors in the manual, for which we apologize.

The data, images and descriptions included in this manual cannot be legally asserted. We reserve the right to make changes and corrections with no prior notice.

